

Front Cover

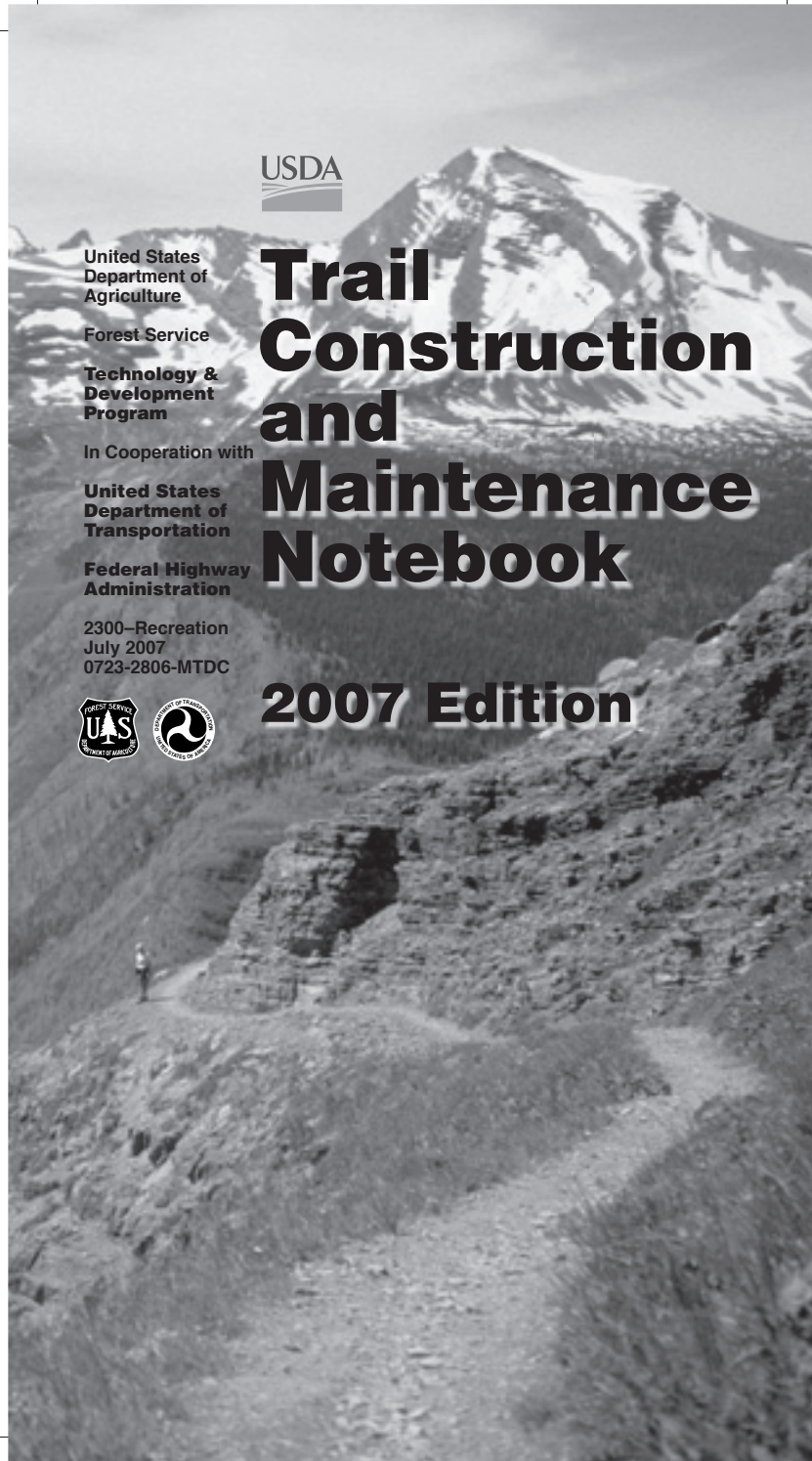

United States
Department of
Agriculture

Forest Service

Technology &
Development
Program

In Cooperation with

United States
Department of
Transportation

Federal Highway
Administration

2300-Recreation
July 2007
0723-2806-MTDC

Trail Construction and Maintenance Notebook

2007 Edition



Inside Front Cover

**You can order a copy of this document using the order form on the
FHWA's Recreational Trails Program Web site at:**

<http://www.fhwa.dot.gov/environment/rectrails/trailpub.htm>

**Fill out the order form and either submit it electronically, fax it to
814-239-2156, or mail it to:**

Szanca Solutions/FHWA PDC
13710 Dunnings Highway
Claysburg, PA 16625

Produced by:

USDA Forest Service • Missoula Technology and Development Center
5785 Hwy. 10 West • Missoula, MT 59808-9361
Phone: 406-329-3978 • Fax: 406-329-3719
E-mail: wo_mtdc_pubs@fs.fed.us



This document was produced in cooperation with the Recreational Trails Program of the Federal Highway Administration, U.S. Department of Transportation.

This document is disseminated under the sponsorship of the U.S. Department of Transportation in the interest of information exchange. The United States Government assumes no liability for its contents or use thereof.

The contents of this report reflect the views of the contractor, who is responsible for the accuracy of the data presented herein. The contents do not necessarily reflect the official policy of the U.S. Department of Transportation.

This report does not constitute a standard, specification, or regulation. The United States Government does not endorse products or manufacturers. Trade or manufacturer's names appear herein only because they are considered essential to the object of this document.

The Forest Service, U.S. Department of Agriculture, has developed this information for the guidance of its employees, its contractors, and its cooperating Federal and State agencies, and is not responsible for the interpretation or use of this information by anyone except its own employees. The use of trade, firm, or corporation names in this document is for the information and convenience of the reader, and does not constitute an endorsement by the Department of any product or service to the exclusion of others that may be suitable.

The U.S. Department of Agriculture (USDA) prohibits discrimination in all its programs and activities on the basis of race, color, national origin, age, disability, and where applicable, sex, marital status, familial status, parental status, religion, sexual orientation, genetic information, political beliefs, reprisal, or because all or part of an individual's income is derived from any public assistance program. (Not all prohibited bases apply to all programs.) Persons with disabilities who require alternative means for communication of program information (Braille, large print, audiotape, etc.) should contact USDA's TARGET Center at (202) 720-2600 (voice and TDD). To file a complaint of discrimination, write to USDA, Director, Office of Civil Rights, 1400 Independence Avenue, S.W., Washington, D.C. 20250-9410, or call (800) 795-3272 (voice) or (202) 720-6382 (TDD). USDA is an equal opportunity provider and employer.

Title Page

i

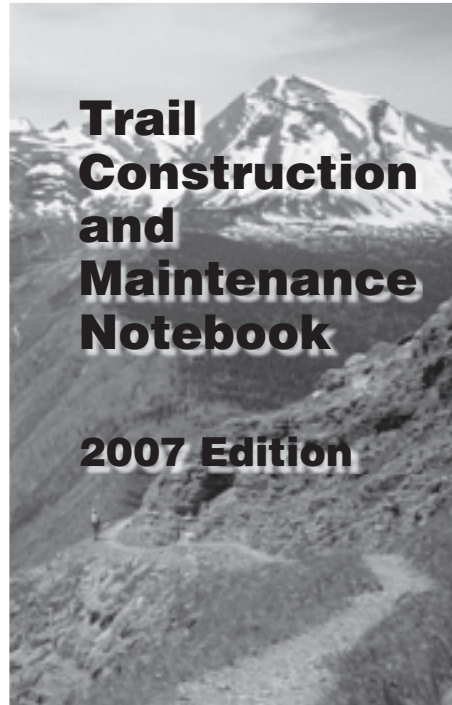

Woody Hesselbarth
*Arapaho-Roosevelt National Forests and
Pawnee National Grassland
Rocky Mountain Region*

Brian Vachowski
Missoula Technology and Development Center

Mary Ann Davies
Project Leader

**USDA Forest Service
Technology and Development Program
Missoula, MT**

6E62A33—Update Trail Construction and
Maintenance Notebook

July 2007

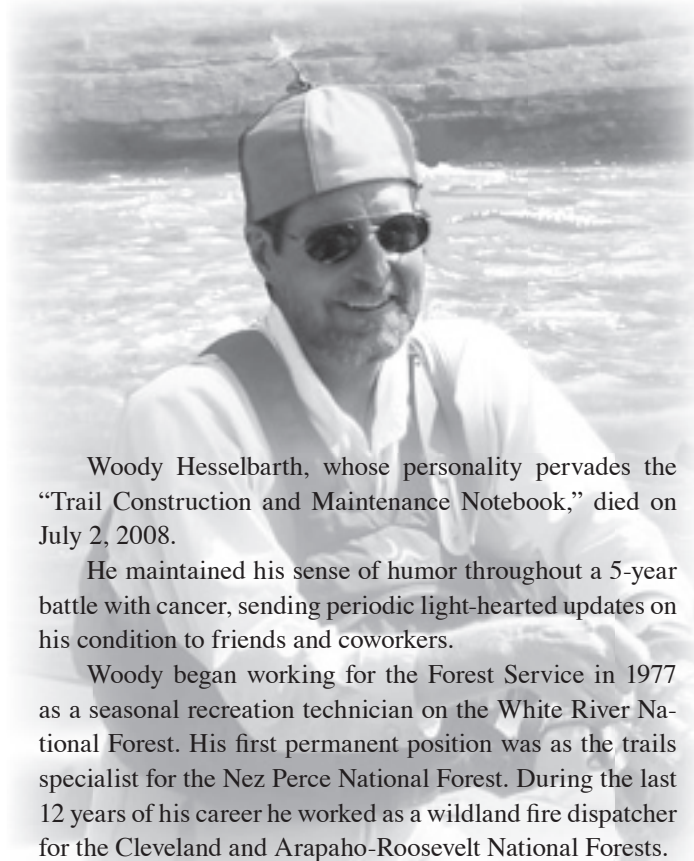

Woody Hesselbarth, whose personality pervades the “Trail Construction and Maintenance Notebook,” died on July 2, 2008.

He maintained his sense of humor throughout a 5-year battle with cancer, sending periodic light-hearted updates on his condition to friends and coworkers.

Woody began working for the Forest Service in 1977 as a seasonal recreation technician on the White River National Forest. His first permanent position was as the trails specialist for the Nez Perce National Forest. During the last 12 years of his career he worked as a wildland fire dispatcher for the Cleveland and Arapaho-Roosevelt National Forests.

At various times, Woody was an avid alpine and Nordic skier, bicycle commuter, search and rescue volunteer (with his search dog Elisha), emergency medical technician, bicycle technician, National Ski Patrol volunteer, and instructor in the Incident Command System (used for emergency preparedness and response).

At all times, Woody was for fun, friends, good music, Hawaiian shirts, and silly hats.

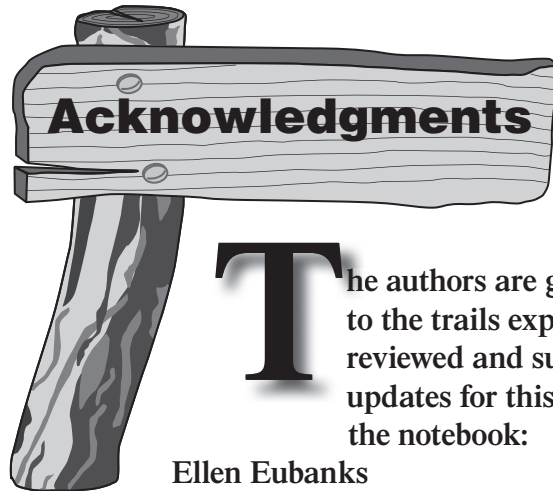

The authors are grateful to the trails experts who reviewed and suggested updates for this revision of the notebook:

Ellen Eubanks
James Scott Groenier
International Mountain Bicycling
Association
Jonathan Kempff
David Michael
Jaime Schmidt

Thanks to Ted Cote, Bert Lindler,
Jerry Taylor Wolf, and Deb Mucci for
their help in the layout and editing of
this revision.



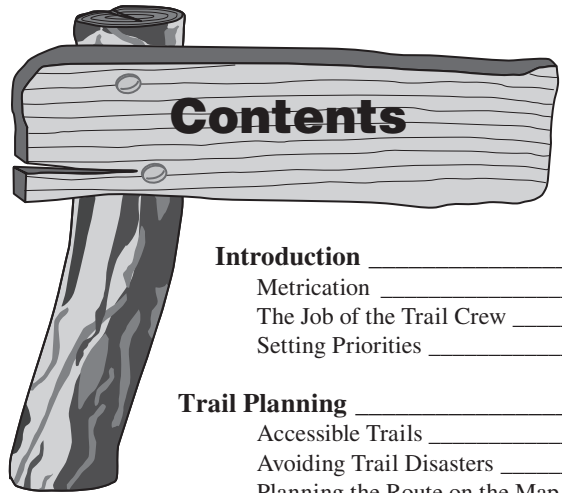

Introduction	1
Metrication	3
The Job of the Trail Crew	4
Setting Priorities	5
Trail Planning	9
Accessible Trails	10
Avoiding Trail Disasters	11
Planning the Route on the Map	12
The 10-Percent Guideline	12
Trail Design	15
Scouting the Route in the Field	15
The Half Rule	17
Trail Specifications	18
Flagging	20
Light on the Land	23
Natural Forces at Work	25
Dirt, Water, and Gravity	25
Critter Effects	26
Surface Water Control	29
Sheet Flow	30
Grade Reversals	31
Draining Water Off Existing Trails	32
Knicks	33
Rolling Grade Dips	34
Waterbars	36
Maintaining the Drain	39
Relocating Problem Sections of Trail	41

Trail Corridor	43
Clearing and Brushing	44
Removing Trees	48
Trail Foundation	51
Rolling Contour Trails	51
Full-Bench Construction	51
Partial-Bench Construction	52
Moving Dirt	54
Tread	57
Outsloping	59
Removing Roots and Stumps	59
Rock Removal	60
Tread Maintenance	62
Slough and Berms	63
Tread Creep	64
Trails in Wet Areas	69
Geosynthetics	70
Rock Underdrains	74
Turnpikes	76
Turnpikes Without Ditches	81
Puncheon	81
Subsurface Puncheon	87
Corduroy	88
Crossing Streams and Rivers	89
Shallow Stream Fords	90
Culverts	93
Bridges	96
Additional Trail Elements	101
Climbing Turns	103
Switchbacks	105
Retaining Walls	111
Steps	116
Pavers	123

Signs	125
Installing Signs	126
Installing Reassurance Markers	128
Maintaining Signs and Markers	132
Reclaiming Trails	135
Check Dams	138
Revegetation	140
Tools	141
Tools for Measuring	142
Tools for Sawing	143
Tools for Chopping	145
Tools for Grubbing	146
Tools for Digging and Tamping	149
Tools for Brushing	150
Tools for Pounding and Hammering	151
Tools for Lifting and Hauling	152
Tools for Peeling and Shaping	155
Tools for Sharpening	155
Mechanized Trail Building Equipment	157
Selected References	161



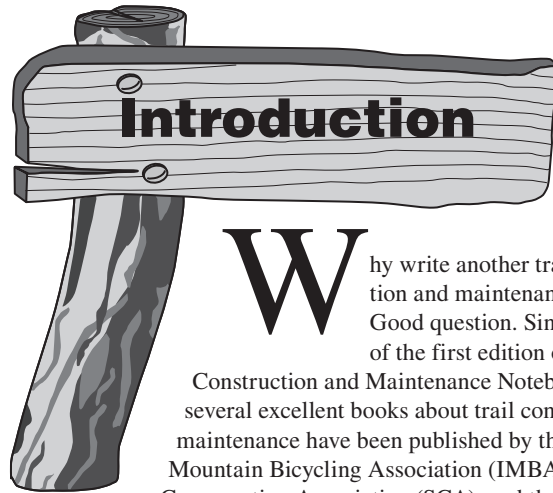

Why write another trail construction and maintenance guide? Good question. Since publication of the first edition of the “Trail Construction and Maintenance Notebook” in 1996, several excellent books about trail construction and maintenance have been published by the International Mountain Bicycling Association (IMBA), the Student Conservation Association (SCA), and the Appalachian Mountain Club, among others. At the same time, this notebook has remained popular, especially because of its pocket size and its wide availability through a partnership between the Forest Service, U.S. Department of Agriculture, and the Federal Highway Administration’s Recreational Trails Program.

Based on helpful critiques of our earlier edition, we made numerous changes to reflect the latest thinking about constructing and maintaining trails. Much remains from the original edition.

True to our original intent, the Missoula Technology and Development Center (MTDC) has again pulled together basic trail construction and maintenance information, presented it in an easy-to-understand fashion, and oriented it to the needs of the trail worker. To keep the notebook’s size manageable, we did not cover tasks such as detailed planning, environmental analysis, or inventory and monitoring. We’ve tried to make sure the notebook is consistent with current Forest Service policies and direction, but it is a practical guide for trail work, not a policy document. We worked to keep the notebook small and readable so it would end up in the packs of trail crew workers instead of under a table leg.

We have included many great references with more detailed information. Many of the Forest Service handbooks and manuals are now available to the general public on the Internet at: <http://www.fs.fed.us/im/directives/>.

Official direction for the USDA Forest Service can be found in:

- Trails Management Handbook (FSH 2309.18)
- Forest Service Standard Specifications for Construction and Maintenance of Trails (EM-7720-103)
- Sign and Poster Guidelines for the Forest Service (EM-7100-15).
- Forest Service Health and Safety Code Handbook (FSH 6709.11)
- Bridges and Structures (FSM 7722 and FSM 7736)

National trail information can be found at: <http://www.fs.fed.us/r3/measures/TR.htm>.

Of special interest are:

- Trail assessment and condition surveys (TRACS). TRACS is the nationally recommended system for conducting field inventory and condition surveys.

On the TRACS page you will find:

- Trail management objectives (TMOs). These objectives are used to establish the trail standard before the condition survey is conducted.
- TRACS data dictionary. This dictionary standardizes terminology for trail features.
- Trail Fundamentals.

On the Trail Fundamentals page you will find:

- Trail class matrix. This matrix provides definitions for the five national trail classes applicable to all National Forest System trails.

New references include "Trail Solutions: IMBA's Guide to Building Sweet Singletrack" (International Mountain Bicycling Association 2004) and a companion DVD, "Building Mountain Bike Trails: Sustainable Singletrack" (Davies and Outka-Perkins 2006), which show how to plan, design, and build fun, sustainable trails. "Natural Surface Trails by Design" (Parker 2004) explores the art of trail design and

layout. Other new references include a comprehensive book on restoration, “Wilderness and Backcountry Site Restoration Guide” (Therrell and others 2006) as well as the “Accessibility Guidebook for Outdoor Recreation and Trails” (Zeller and others 2006).

There are many regional differences in trail building and maintenance techniques, tools, and terminology. The TRACS data dictionary is an attempt to standardize trail terminology. We hope you aren’t offended if your favorite technique has been left out or called a funny name.

Little about trail work is “new.” Our culture, though, has forgotten a lot about trails. When we attempt our first trail project, most of us know very little about water and dirt.

Do it Your Way

You might not do things the way they are described in this notebook—that’s cool! Understanding why things are done a certain way is at least as important as doing them a certain way. If you know why something is happening, you’ll figure out a way to solve the problem. Soak up the core concepts. Experiment and keep track of the results. Be curious. Add new techniques and tactics to your bag of tricks. Get dirty and *HAVE FUN!*

Metrication

Metrication lives! Standard International (SI) units of measurement (metric) are used throughout the text, followed by roughly equivalent English measurements in parentheses. A handy conversion chart on the inside back cover can help the metrically challenged make conversions.

One other word on measurements. Most crews don’t haul measur-

ing tapes around to measure things. A really handy way of keeping track of commonly used measures is to mark them on tool handles. For example, if the typical tread for your project is supposed to be 600 millimeters (24 inches), mark 600 millimeters on your tool handle.

The Job of the Trail Crew

The most important thing in trail work is your personal well-being and safety. Are you fit? Do you know your limitations? Do you have the skills you need?

Your personal gear, clothing, and safety equipment are important. Let's start with your feet. Trail work can take you into rough country. Cut-resistant or leather nonskid boots, at least 200 millimeters (8 inches) high, offer the best support and ankle protection. They are required by the Forest Service if you are using cutting, chopping, or digging tools. Steel-toed boots are a good choice when working with rock. Ankle-high hiking boots are okay for some trail work. Sneakers or tennis shoes do not give enough support and protection. Be aware of regional differences. In southeastern Alaska, for example, rubber boots are the norm for most trail work.

Pants give more protection than shorts from cuts and scrapes, insects, and sunburn. Long-sleeved shirts are best for the same reasons. Bring your foul-weather gear. You won't forget work gloves more than once. Drinking water, lip moisturizer, sunscreen, sunglasses, insect repellent, and personal medications round out the list of personal items for your pack.

Hardhats are an agency requirement for many types of trail work, especially when swinging tools, working under the canopy of trees, or when there is any chance of being hit on the head. Other safety gear includes eye protection for any type of cutting or rock work, hearing protection near power equipment (85 dB or louder), and dust masks for some types of rock work and in extremely dusty conditions. Don't start the job unless you are properly equipped. Take a look at the Forest Service Health and Safety Code Handbook (FSH 6709.11) for some good information that could save your life.

Your crew will need a first aid kit. At least one person needs to be certified to give first aid and perform CPR (cardiopulmonary resuscitation). The project leader and involved employees will prepare a job hazard analysis that includes:

- An itinerary (planned route of travel, destination, estimated time of departure/arrival)

- The names of the employees on the crew
- Specific work hazards and abatement actions
- An emergency evacuation plan

Hold safety briefings before work begins and whenever conditions change significantly.

Setting Priorities

Priorities depend on many factors. Are you laying out and designing a new trail? If you are, start with good planning and a sustainable design to minimize future maintenance.

Are you assessing an older trail that may not be in the most ideal place? How much maintenance is too much? When do you decide to reroute sections?

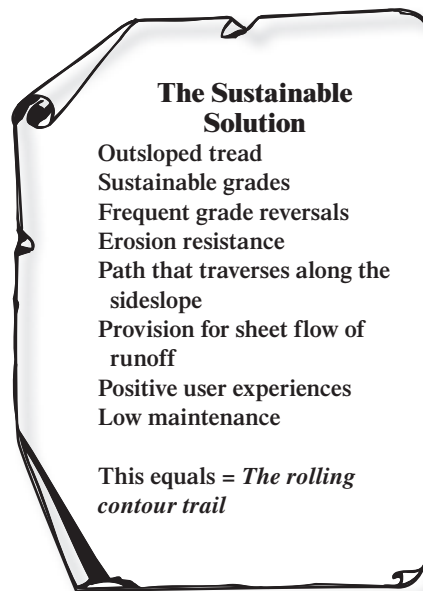

If you're designing a new trail, make sure it will be sustainable (figure 1). What does that mean? Sustainability means creating and maintaining trails that are going to be here for a long time. Trails with tread that won't be eroded away by water and use. Trails that won't affect water quality or the natural ecosystem. Trails that meet the needs of the intended users and provide a positive user experience. Trails that do no harm to the natural environment.



Figure 1—A rolling contour trail resists erosion.

You need teachers and experience to learn how to lay out and design sustainable trails. Learn from the best. Shop around, talk to other trail builders, check out their work. Attend trail building sessions in your area or have a group of experienced trail builders, such as an IMBA Trail Care Crew (<http://www.imba.com/tcc/>) visit your area. Learn, learn, learn. You want people to come off your trail saying, “Wow—that was great! Let’s do it again.”

The trail crew’s task is to keep water off the tread and keep the users on it. The best trail maintainers are those with *trail eye*, the ability to anticipate physical and social threats to trail integrity and to head off problems.

Because there will always be more work to do than people or time to do it, how do you decide what to do? It’s important to:

- Monitor trail conditions closely.
- Decide what can be accomplished as basic maintenance.

- Determine what can be deferred.
- Identify the areas that will need major work.

Trail triage will help you spend your maintenance dollars wisely.

Trail Triage

1. Correct truly unsafe situations. As examples, repair impassable washouts along a cliff and remove blowdown from a steep section of a trail used by packstock.
2. Correct problems that are causing significant trail damage, such as erosion.
3. Restore the trail to the planned design standard. The ease of finding and traveling the trail should match the design specifications for the recreational setting and target users. Actions can range from simply adding reassurance markers along a trail to a full-blown reroute of poorly designed sections of eroded trail.

Whatever the priority, maintain the trail when the need is first noticed to prevent more severe and costly damage later.



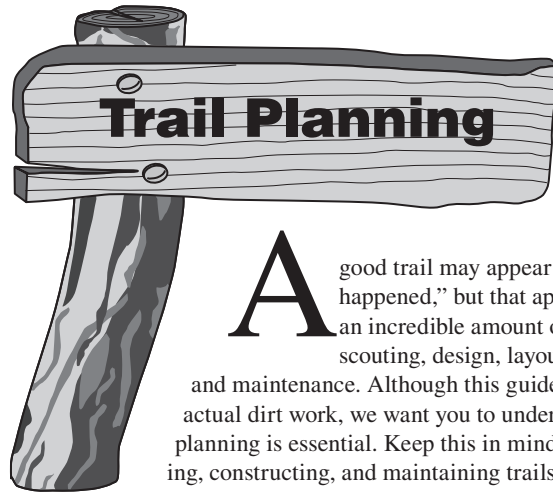

A good trail may appear to have “just happened,” but that appearance belies an incredible amount of work in scouting, design, layout, construction, and maintenance. Although this guide focuses on actual dirt work, we want you to understand that solid planning is essential. Keep this in mind when designing, constructing, and maintaining trails (figure 2).

Recreation trails are for all people. They allow us to go back to our roots. Trails help humans make sense of a world increas-



Figure 2—Design and construct your trail to fit the land.

ingly dominated by automobiles and pavement. They put us in touch with our natural surroundings, soothe our psyches, challenge our bodies, and allow us to practice traditional skills.

Human psychology also plays a role. A useful trail must be easy to find, easy to travel, and convenient to use. Trails exist simply because they are an easier way of getting someplace. Many trails, such as wilderness trails, motorcycle routes, or climbing routes, are deliberately challenging with a relatively high degree of risk. Rest assured, however, that if your official trail isn't the *path of least resistance*, users will create their own trail. Your trail must be more obvious, easier to travel, and more convenient than the alternatives or you're wasting your time and money.

Accessible Trails

The Forest Service Trail Accessibility Guidelines (FSTAG), which became official agency policy in May 2006, recognize and protect the environment and the natural setting while integrating accessibility where possible. These guidelines are available at <http://www.fs.fed.us/recreation/programs/accessibility>.

Forest Service trail designers must approach the design of hiker or pedestrian trail projects that connect to an accessible trail or trailhead with the intent of developing trails that are accessible to all users, including those with disabilities. Four "conditions for departure" waive the accessibility requirements for most existing primitive, long-distance trails, and new trails built on very steep terrain. The guidelines apply only on National Forest System lands.

To help trail designers integrate the requirements of the Trail Accessibility Guidelines into planning, design, construction, and maintenance of trails, the Forest Service developed the "Accessibility Guidebook for Outdoor Recreation and Trails." The guidebook provides detailed information about accessibility requirements in an

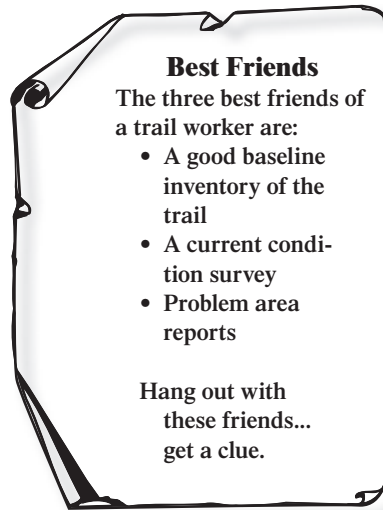

easy-to-use format with photos, illustrations, design tips, hotlinks, and sidebars. The guidebook is available at <http://www.fs.fed.us/recreation/programs/accessibility>.

Avoiding Trail Disasters

If you've ever encountered a trail disaster, chances are that it resulted from short-circuited planning. Acts of

God aside, some of the worst trail problems result from not doing the hard work of thinking before putting on the gloves and hardhat. Some glaring examples are:

- Building out-of-rhythm sections (abrupt turns). Why did this happen? The trail's rhythm and flow weren't checked before cutting it in.
- Water funneling down and eroding the tread. Why did this happen? The trail grade was designed too steep.
- Multiple trails. Why did this happen? The trail wasn't laid out in the best place to begin with.

Planning is stupidity avoidance. Do good planning for all levels of trail work.

Good planning also includes monitoring the trail's condition. It's hard to do good planning until you have some idea of the current situation and trend.

Our focus in this notebook is field work, but other important work goes into trail planning. Requirements for trail planning vary, but they usually include consulting soil scientists, bridge and geotechnical engi-

neers, fisheries and wildlife biologists, recreation planners, landscape architects, and persons skilled in documenting environmental and permitting requirements.

Planning the Route on the Map

Be certain you know the trail management objectives (TMOs) for your trail—things like the intended users, desired difficulty level, and desired experience. TMOs provide basic information for trail planning, management, and reporting.

Use topographic maps and aerial photos to map the potential route. On the map, identify control points—places where the trail has to go, because of:

- Destination
- Trailheads
- Water crossings
- Rock outcrops

Include *positive control points*—features such as a scenic overlook, a waterfall, or lakes.

Avoid *negative control points*—areas that have noxious weeds, threatened and endangered species, critical wildlife habitat, or poor soils.

The 10-Percent Guideline

When plotting the trail on a map, connect the control points, following contour lines. Keep the grade of each uphill and downhill section less than 10 percent. Plotting your trail with 10-percent grades on a topographic map will help keep the route at a sustainable grade. When you get into the field to start scouting the route, you'll have better flexibility to tweak the grades.

Percent Grade

- Grade can be expressed as a percent or an angle. Percent is easier to understand.
- *Percent* grade equals the *rise* (elevation change) divided by the *run* (horizontal distance) multiplied by 100.
- Example: $\frac{\text{rise of 10 feet}}{\text{run of 100 feet}} \times 100 = 10 \text{ percent}$
- Elevation change, up or down, is always a positive number.



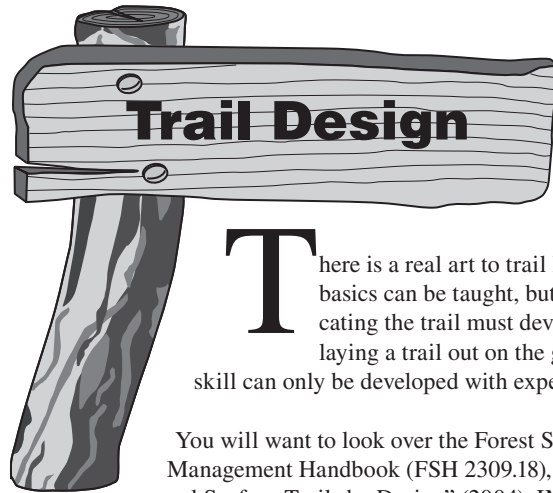

There is a real art to trail layout. Some basics can be taught, but the person locating the trail must develop an eye for laying a trail out on the ground. This skill can only be developed with experience.

You will want to look over the Forest Service Trails Management Handbook (FSH 2309.18), Parker's "Natural Surface Trails by Design" (2004), IMBA's "Trail Solutions" (2004), and MTDC's "Building Mountain Bike Trails: Sustainable Singletrack" DVD (Davies and Outka-Perkins 2006). These references have a lot of good information to help you do a good job of trail layout.

Scouting the Route in the Field

Tools to scout the route include: clinometer, compass, altimeter, GPS receiver, flagging of different colors, wire pin flags, roll-up pocket surveyor's pole, permanent marker to write notes on the flagging, field book, probe to check soil depth to bedrock, and maps. The objectives of scouting or reconnaissance are to:

- Verify control points and identify additional control points that you did not spot when you were studying the maps and aerial photos.
- Verify that the mapped route is feasible.
- Find the best alignment that fits all objectives.

- Identify additional positive control points to enhance the user's experience.
- Validate that the route is reasonable to construct and maintain.

Hints for Locators

- Don't trust an eyeball guess for grade; use your clinometer (**clino**).
- Large trees often have natural benches on their uphill side. It's better to locate your trail there than on the downhill side where you'll sever root systems and generally undermine the tree. Your specifications will tell you how close the trail can be to the tree.
- Look for natural platforms for climbing turns or switchbacks. They save construction costs and better fit the trail to the land.
- Cross ravines at an angle rather than going straight up and down the ravine banks.
- Flag locations for grade reversals.
- Look for indications of shallow bedrock, such as patches of sparse vegetation.
- Flag the centerline location, particularly in difficult terrain.
- Look for small draws to locate grade reversals. The trail should climb gently for a few feet on each side of the draw.
- Avoid laying a trail out on flat terrain because water has no place to drain.

Field scouting requires sound knowledge of map and compass and of finding your way on the ground. Begin with the theoretical route, then try different routes until you find the best continuous route between control points. **Walk, walk, walk.** Keep field notes of potential routes.

It may be useful to hang reference flags at potential control points or features so they are easier to relocate later.

Reconnaissance is easiest with two people. You and your partner need to use a clinometer to determine sustainable grades.

The Half Rule

Building sustainable trail grades helps keep maintenance at bay. So what makes a grade sustainable? This design element comes from IMBA's "Trail Solutions" book (2004). It's called the *half rule*.

The half rule says that the trail grade should be no more than half the sideslope grade (figure 3). This rule really helps when putting trails on gentle sideslopes. For example, if you're working on a hill with a

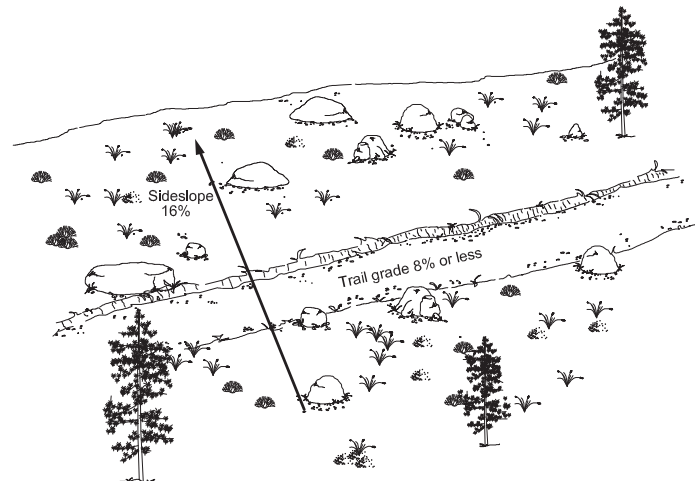

Figure 3—The trail grade shouldn't be more than half the grade of the sideslope. This is the half rule.

6-percent sideslope, your trail grade should be no more than 3 percent. If the trail is any steeper, it will be a fall-line trail.

Fall-line trails let water funnel down, causing erosion and ruts. As sideslopes get steeper, trails designed using the half rule can be too steep. Use your judgment and knowledge of the particular area.

Trail Specifications

Specifications are important too. You'll want to refer to the Forest Service Trails Management Handbook (FSH 2309.18) for guidelines on building almost any type of trail.

All trails are not created equal. Ideally, each trail is designed, constructed, and maintained to meet certain specifications. These specifications are based on the recreational activities the trail is intended to provide, the amount of use, and the physical characteristics of the land. Ecological and esthetic considerations are also important.

For example, a narrow winding trail might be the right choice for foot traffic in the backcountry (figure 4), while a wider trail tread with broad sweeping turns would be appropriate for an ATV (all-terrain vehicle) route. A smooth trail with gentle grades (figure 5) is more appropriate for an interpretive trail or a trail designed for persons with disabilities. Challenging trails that include rocky boulder fields and some jumps might be designed for mountain bikes and motorcycles.

The steepness of the hillside determines how difficult a trail is to build. The steeper the hillside, the more excavation will be needed to cut in a stable backslope. Trail grade also has a direct bearing on how much design, construction, and maintenance work will be needed to establish solid tread and keep it solid. Grades range from 1 percent for wheelchair access to 50 percent or greater for scramble routes. Most high-use trails should be constructed with an average trail grade in the

5- to 10-percent range. Trails of greater difficulty can be built at grades approaching 15 percent if solid rock is available. Trails steeper than 20 percent become difficult to maintain in the original location without resorting to steps or hardened surfaces.



Figure 4—A narrow, winding trail might be the right choice for foot traffic in the backcountry.



Figure 5—Two friends enjoy an accessible trail that allows them to hike through the rain forest.

Flagging

Use *flagging tape* to mark the trail opening or corridor. Use colors that stand out from the vegetation. Fluorescent pink should work in most areas.

You will need to use the clino to keep the trail's grade within the limits of the half rule.



Using the Clino: Zeroing Out

- You and your partner stand on flat ground facing each other.
- Look through the clino and line up the horizontal line on zero.
- Open your other eye and see where the horizontal line intersects a spot on your partner.
- Use this spot on your partner for reading grades with the clino.
- Always read the scale on the right—this is the percent scale.

Two or More Persons Flagging—Stand on the centerline point, direct your partner ahead to the desired location, then take a reading with your clino. When the desired location is determined, the front person ties a piece of flagging on vegetation with the knot facing the intended trail, then moves ahead. The person with the clino moves up to the flagging and directs the next shot. A third person can be scouting ahead for obstacles or good locations.

One-Person Flagging—

Stand at a point that is to be the centerline and tie flagging at eye level. Then move about 3 to 6 meters (10 to 20 feet) to the next centerline point and sight back to the last flag. When you have the desired location, tie another piece of flagging at eye level.

Flagging the Route—Flagging marks your intended trail layout on the ground. While flagging the route, you will discover impassable terrain, additional control points, and obstacles that weren't evident on the map. Use different colors of flagging for the other possible routes as you lay in the trail options. Always use a clino to measure sustainable grades.



Go Flashing

If you're working in heavy brush and you can't see your partner through the clino, have your partner wiggle a bright flashlight.

Start by tying flagging to the branches of trees at eye level and about every 3 meters (10 feet). Don't forget to tie the knot so that it faces the intended trail location. This way, if another crew continues the work, they will know your intentions.

Don't scrimp. Flagging is cheap compared with the time spent locating the route. Animals carry off flagging, and wind blows it down. Flagging that is close together helps trail designers and builders visualize the flow of the trail.

If you are working in an open area without trees or shrubs, use pin flags instead of flagging.

Marking the Final Alignment—Pin flags mark the exact location of the trail tread (figure 6). *Pin flags* can be placed on the trail's centerline or on its uphill or downhill side. Just make sure the crew knows where the trail will be relative to the pin flags. Place pin flags every 3 meters (10 feet) or so. More is better.



Figure 6—Pin flags mark the exact location of the trail tread and give you a good feel for the flow of the trail.

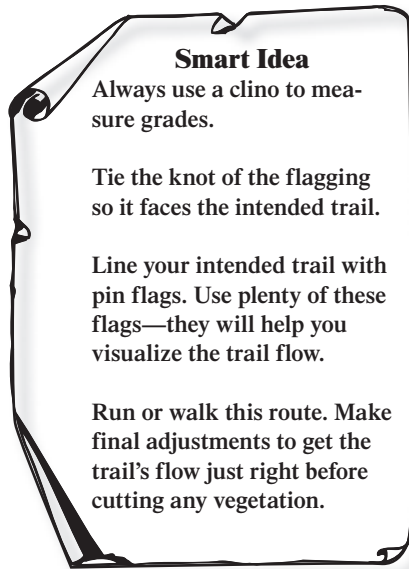

Now, run or walk the trail. This gives you a good feel for the flow of the trail. Make adjustments and move the flags if a turn feels too sharp or a section has too much straight-away. When your trail alignment feels really good and you're satisfied with the locations of the pin flags, have the land manager check your design. You'll need to have the manager's approval before cutting any vegetation or removing any dirt.

Light on the Land

No discussion of trails is complete without attention to esthetics. We're talking scenic beauty here. Pleasing to the eye.

The task is simple. An esthetically functional trail is one that fits the setting. It lies lightly on the land and often looks like it just "happened."

Well-designed trails take advantage of natural drainage features, reducing maintenance that might be needed, while meeting the needs of the users. The trail might pitch around trees and rocks, follow natural benches, and otherwise take advantage of natural land features (figure 7).



Figure 7—Well-designed trails take advantage of natural land features.

The best trails show little evidence of the work that goes into them. A little extra effort spent limbing properly, scattering cut vegetation widely, blending backslopes, avoiding drill hole scars, raking leaves back over the scattered dirt, and restoring borrow sites pays off in a more natural-looking trail. Be a master. Do artful trail work.

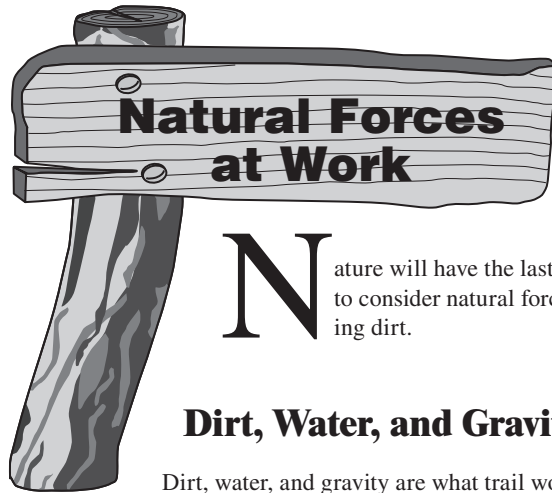

Nature will have the last word. It's best to consider natural forces before moving dirt.

Dirt, Water, and Gravity

Dirt, water, and gravity are what trail work is all about. **Dirt** is your trail's support. Terra firma makes getting from point A to point B possible. The whole point of trail work is to get dirt where you want it and to keep it there. **Water** is the most powerful stuff in your world. **Gravity** is water's partner in crime. Their mission is to take your precious dirt to the ocean. The whole point of trail work is to keep your trail out of water's grip (figure 8).

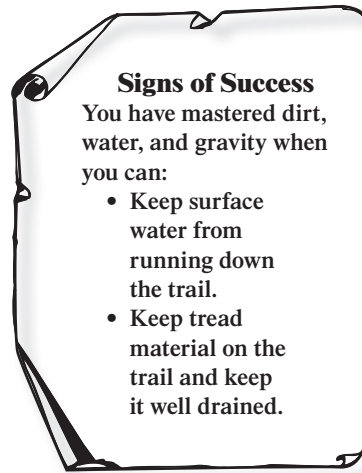

Figure 8—Water and gravity join forces to erode trail tread.

It's much more important to understand how the forces of water and gravity combine to move dirt than it is to actually dig dirt. If you put in many years building trails, you will see hundreds of examples of trails built with little understanding of the forces at hand. You will save time, money, and your sanity if you get grounded in the basic physics.

Water in the *erode mode* strips tread surface, undercuts support structures, and blasts apart fill on its way downhill. The amount of damage depends on the amount of water involved and how fast it is moving.

Water has *carrying capacity*. More water can carry more dirt. Faster water can carry even more dirt. You need to keep water from running down the trail! When and where you can do that determines the sort of water control or drainage structure you use.



Water also can affect soil strength. While the general rule of thumb is that drier soils are stronger (more cohesive) than saturated soils, fine, dry soils may blow away. The best trail workers can identify basic soils in their area and know their wet, dry, and wear properties. They also know plant indicators that tell them about the underlying soil and drainage.

Critter Effects

Gravity has a partner—the critter. Critters include packstock, pocket gophers, humans, bears, elk, deer, cows, and sheep. Critters burrow through the tread, walk around the designated (but inconvenient) tread,

tightrope walk the downhill edge of the tread, shortcut the tread, roll rocks on the tread, chew up the tread, or uproot the tread.

Gravity waits in glee for critters to loosen up more soil. If you recognize potential critter effects (especially from humans, deer, elk, domestic livestock, and packstock), you can beat the system for awhile and hang onto that dirt:

- Don't build switchbacks across a ridge or other major "game route."
- Don't let tread obstacles like bogs or deeply trenched tread develop.
- Make it inconvenient for packstock to walk the outer edge of your tread.

Your trail strategies are only as good as your understanding of the critter's mind.



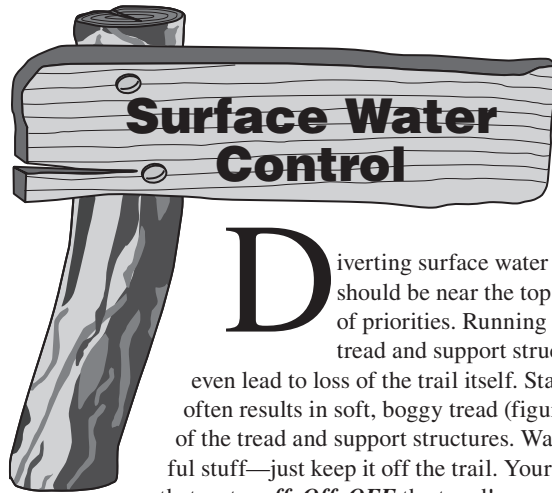

Diverting surface water off the trail should be near the top of your list of priorities. Running water erodes tread and support structures, and can even lead to loss of the trail itself. Standing water often results in soft, boggy tread (figure 9) or failure of the tread and support structures. Water is wonderful stuff—just keep it off the trail. Your job is to keep that water *off, Off, OFF* the tread!



Figure 9—Standing water results in soft, boggy tread.

The very best drainage designs are those built into new construction. These include frequent grade reversals and outsloping the entire tread. The classic mark of good drainage is that it's self-maintaining, requiring minimal care.

Sheet Flow

When rain falls on hillsides, after the plants have all gotten a drink, the water continues to flow down the hill in dispersed sheets—called *sheet flow* (figure 10). All the design elements for a rolling contour trail—building the trail into the sideslope, maintaining sustainable grades, adding frequent grade reversals, and outsloped tread—let water continue to sheet across the trail where it will do little damage.

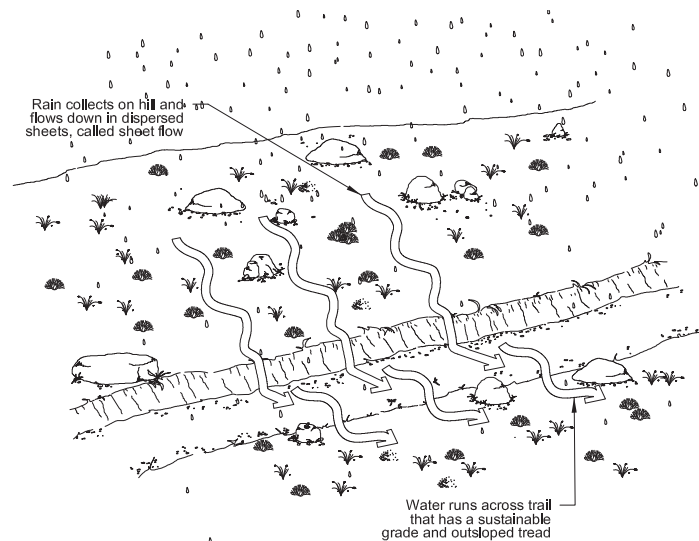

Figure 10—Design elements for a rolling contour trail let water sheet across the trail. Sheet flow prevents water from being channeled down the trail, where it could cause erosion.

Grade Reversals

Sometimes, grade reversals are called grade dips, terrain dips, Coweeta dips, or swales. For less confusion, let's call them *grade reversals*. The basic idea is to use a reversal in grade to keep water moving across the trail. Grade reversals are designed and built into *new trails*.

A trail with grade reversals and outsloped tread encourages water to continue sheeting across the trail—not down it. The beauty of grade reversals is that they are the most unobtrusive of all drainage features if they are constructed with smooth grade transitions. Grade reversals require very little maintenance.

Grade reversals take advantage of natural dips in the terrain (figure 11). The grade of the trail is reversed for about 3 to 5 meters (10 to 15 feet), then “rolled” back over to resume the descent. Grade reversals should be placed frequently, about every 5 to 15 meters (20 to 50 feet). A trail that lies lightly on the land will take advantage of natural dips and draws for grade reversals. The trail user's experience is enhanced by providing an up-and-down motion as the trail curves up and around large trees (figure 12) or winds around boulders.



Figure 11—Grade reversals are much more effective than waterbars and require less maintenance. Grade reversals with outsloped tread are the drainage structure of choice.



Figure 12—Enhance the user’s experience and create a grade reversal by curving the trail around large trees and rocks.

Draining Water Off Existing Trails

Water will always find the path of least resistance—most likely your trail! Gullies form as water eats away the tread material on steep trails. Puddles sit in low-lying areas that leave the water nowhere to go. When water starts destroying your trail, trail users start skirting around the damage. The trail becomes wider or multiple new trails are formed.

Getting water off the trail takes more than digging a drainage ditch. Find out where the water is coming from, then find a way to move it off the trail.

When a crew takes a swipe at the berm with a shovel or kicks a hole through it—that’s useless drainage control. These small openings are

rapidly plugged by floating debris or the mud-mooshing effect of passing traffic. The erosion lives on.

Knicks

Puddles that form in flat areas on existing trails may cause several kinds of tread damage. Traffic going around puddles widens the trail (and eventually the puddle). Standing water usually weakens the tread and the backslopes. Water can cause a bog to develop if the soils are right. Traffic on the soft lower edge of a puddle can lead to *step-throughs*, where users step through the edge of the trail, breaking it down. Step-throughs are one of the causes of tread creep.

The *knick* is an effective outsloped drain. Knicks are constructed into *existing trails* (figure 13). For a knick to be effective, the trail tread must have lower ground next to it so the water has a place to drain. A

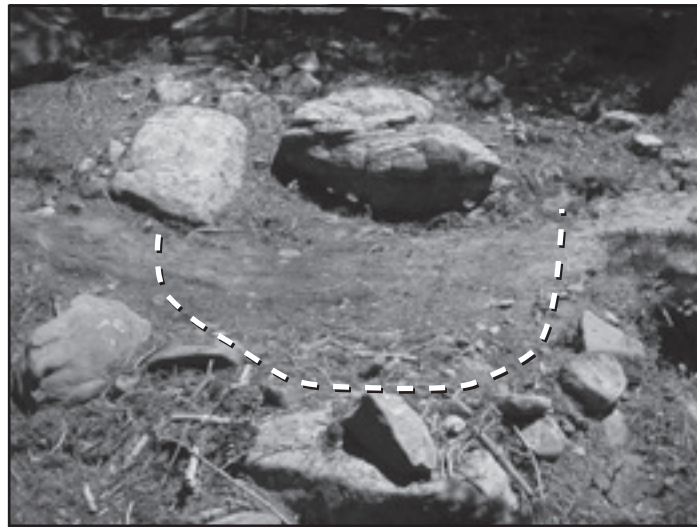

Figure 13—Knick constructed into existing trails will drain puddles from flat areas.

knick is a shaved down semicircle about 3 meters (10 feet) long that is outsloped about 15 percent in the center (figure 14). Knicks are smooth and subtle and should be unnoticeable to users.

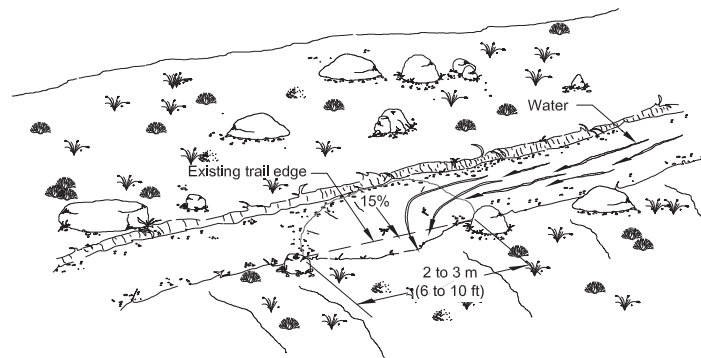

Figure 14—A knick is a semicircle cut into the tread, about 3 meters (10 feet) long and outsloped 15 percent in the center.

If terrain prevents such outsloping, the next best solution is to cut a *puddle drain* at least 600 millimeters (24 inches) wide, extending across the entire width of the tread. Dig the drain deep enough to ensure that the water will flow off the tread. Feather the edges of the drain into the tread so trail users don't trip. Plant rocks or other large stationary objects (guide structures) along the lower edge of the tread to keep traffic in the center. In a really long puddle, construct several drains at what appear to be the deepest spots.

Rolling Grade Dips

Another way to force water off *existing trails* is to use a *rolling grade dip*. A rolling grade dip is used on steeper sections of trail. It also works well to drain water off the lower edge of contour trails. A rolling grade dip builds on the knick design. A rolling grade dip is a knick with a long ramp about 4 ½ meters (15 feet) built on its downhill side (figure 15). For example, if a trail is descending at a 7-percent grade, a rolling grade dip includes:

- A short climb of 3 to 5 meters (10 to 20 feet) at 3 percent
- A return to the descent (figure 16).

Water running down the trail cannot climb over the short rise and will run off the outsloped tread at the bottom of the knick. The beauty of this structure is that there is nothing to rot or be dislodged. Maintenance is simple.

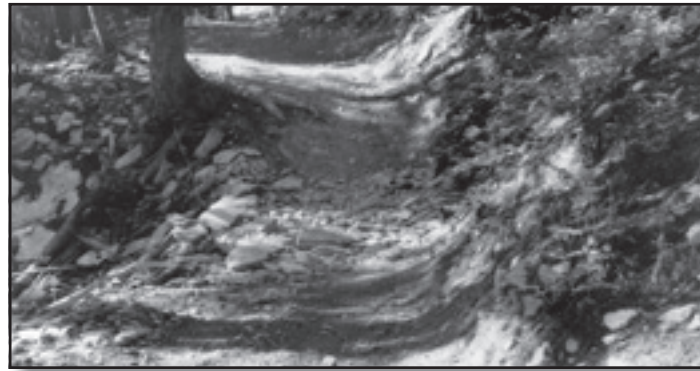

Figure 15—Rolling grade dips direct water off steeper sections on existing trails.

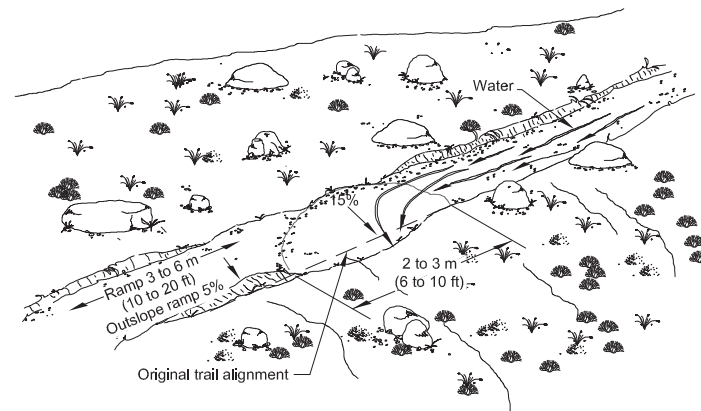

Figure 16—A rolling grade dip builds on the knick design. It helps direct water off steeper sections of existing trail.

Rolling grade dips should be placed frequently enough to prevent water from building up enough volume and velocity to carry your tread's surface away. Rolling grade dips are pointless at the top of a grade. Mid-slope usually is the best location. The steeper the trail, the more rolling grade dips will be needed. Rolling grade dips should not be constructed where they might send sediment-laden water into live streams.

Waterbars

Waterbars are commonly used drainage structures. Make sure that waterbars are installed correctly and are in the right location. Water moving down the trail turns when it contacts the waterbar and, in theory, is directed off the lower edge of the trail (figure 17).

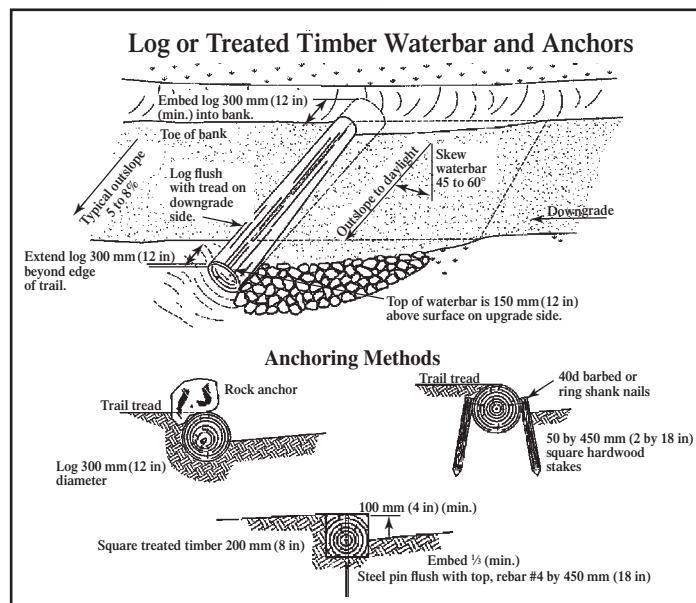

Figure 17—Logs used for waterbars need to be peeled (or treated with preservative), extended at least 300 millimeters (12 inches) into the bank, staked or anchored, and mostly buried.

Dips Are In, Bars Are Out

For existing trails with water problems, we encourage the use of rolling grade dips or knicks instead of waterbars. Here's why. By design, water hits the waterbar and is turned. The water slows down and sediment drops in the drain.

Waterbars commonly fail when sediment fills the drain. Water tops the waterbar and continues down the tread. The waterbar becomes useless. You can build a good rolling grade dip quicker than you can install a waterbar, and a rolling grade dip works better.

On grades of less than 5 percent, waterbars are less susceptible to clogging unless they serve a long reach of tread or are constructed in extremely erodible tread material. On steeper grades (15 to 20 percent), waterbars are prone to clogging if they are at less than a 45-degree angle to the trail. Waterbars are mostly useless for grades steeper than 20 percent. At these grades a very fine line exists between clogging the drain and eroding it (and the waterbar) away.

Most waterbars are not installed at the correct angle, are too short, and don't include a grade reversal. Poorly constructed and maintained waterbars become obstacles and disrupt the flow of the trail. The structure becomes a low hurdle for travelers, who walk around it, widening the trail.

A problem with wooden waterbars is that horses can kick them out. Rock, if available, is always more durable than wood (figure 18). Cyclists of all sorts hate waterbars because the exposed surface can be very slippery, leading to crashes when a wheel slides down the face of the waterbar. As the grade increases, the angle of the waterbar (and often the height of its face) is increased to prevent sedimentation, raising the crash-and-burn factor.

Rock Waterbar

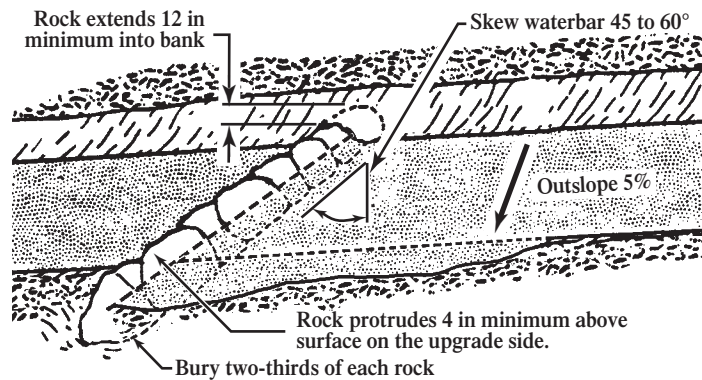

Figure 18—Waterbars need to be constructed at a 45- to 60-degree angle to the trail. Rock waterbars are more durable than wood.

Are waterbars ever useful? Sure. Wood or rock waterbars are useful on foot and stock trails where a tripping hazard is acceptable, especially at grades less than 5 percent. Also consider reinforced or armored grade dips where you don't have much soil to work with and in areas that experience occasional torrential downpours.

A variation from the traditional waterbar is the *waterbar with riprap tray*. The riprap tray is built with rock placed in an excavated trench. The tops of the rocks are flush with the existing tread surface, so they're not an obstacle to traffic. Next, construct a rock waterbar. Use *rectangular rocks*, chunkers, butted together, not overlapped. Start with your heaviest rock at the downhill side—that's your *keystone*. Lay rocks in from there until you tie into the bank. Bury two-thirds of each rock at a 45- to 60-degree angle to the trail.

Add a retainer bar of rock angled in the opposite direction from the waterbar. The downhill edge of the retainer bar is at an angle so it nearly touches the downhill edge of the waterbar (figure 19). Fill the space between the waterbar and retainer with compacted tread material.

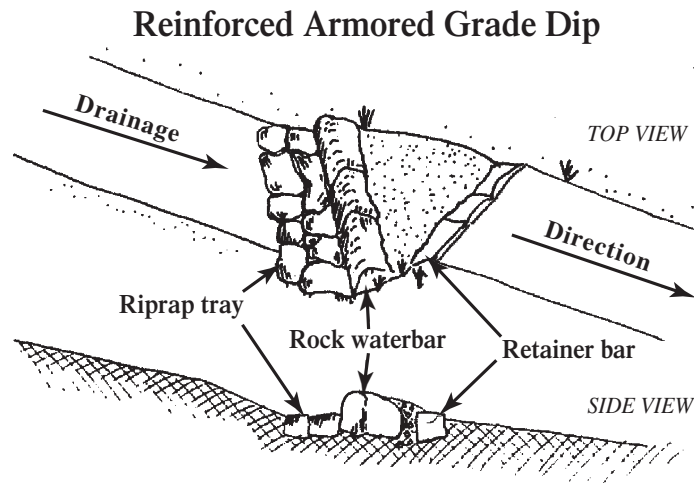

Figure 19—A waterbar with a riprap tray.

Maintaining the Drain

The number one enemy of simple drains is sediment, especially at waterbars. If the drain clogs, the water you are trying to get rid of either continues eroding its way down the tread, or just sits there in a puddle.

The best drains are self-cleaning; that is, the flow of water washes sediment out of the drain, keeping it clean. In the real world most drains collect debris and sediment that must be removed or the drain will stop working. Because it may be a long time between maintenance visits, the drain needs to handle annual high-volume runoff without failing (figure 20).

The best cure for a waterbar that forces the water to turn too abruptly is to rebuild the structure into a rolling or armored grade dip.

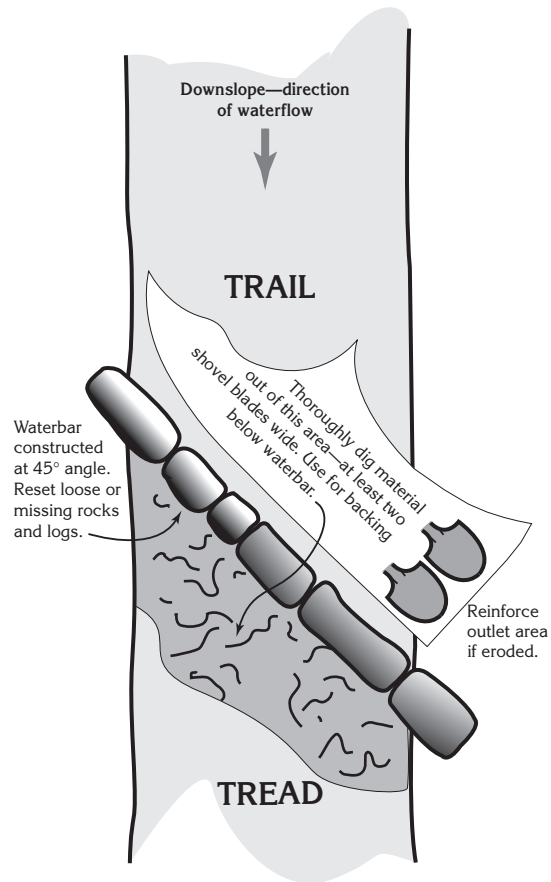

Figure 20—The key to waterbar maintenance is to ensure that sediment will not clog the drain before the next scheduled maintenance. Embed the rocks or logs a little deeper, cover them with soil, and you have a reinforced waterbar.

Walking in the Rain

A lot of learning takes place when you slosh over a wet trail in a downpour and watch what the water is doing and how your drains and structures are holding up. Figure out where the water is coming from and where it's going. Think about soil type, slope, distance of flow, and volume of water before deciding your course of action.

Relocating Problem Sections of Trail

If you've tried various drainage methods and water is still tearing up your trail, it's time to think seriously about rerouting the problem sections. Reroutes are short sections of newly constructed trail. This is your chance to incorporate all the good design features of a rolling contour trail that encourages water to sheet across the trail. Remember the good stuff:

- Locating the new section of trail on a sideslope
- Keeping the trail grade less than half of the grade of the hillside
- Building with a full bench cut to create a solid, durable tread
- Constructing plenty of grade reversals
- Outsloping the tread
- Compacting the entire trail tread

Make sure the new section that connects to the old trail has nice smooth transitions—no abrupt turns.

Some short sections of eroded trails may not be major problems. If the trail surface is rocky—and water, use, and slopes are moderate—this section could eventually stabilize itself. A short section of eroded trail may cause less environmental damage than construction of a longer rerouted section. Weigh your options wisely.

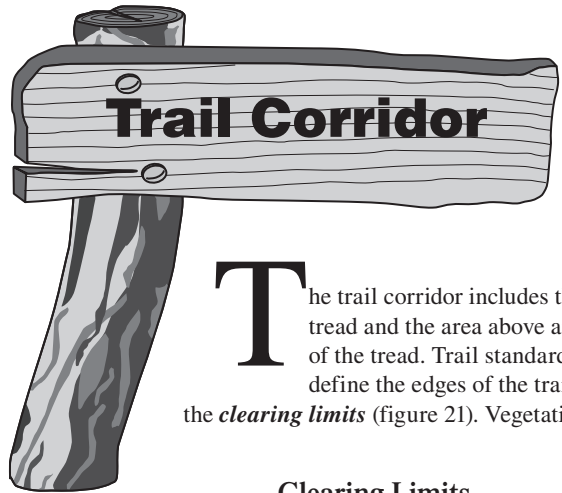

The trail corridor includes the trail's tread and the area above and to the sides of the tread. Trail standards typically define the edges of the trail corridor as the *clearing limits* (figure 21). Vegetation is trimmed

Clearing Limits

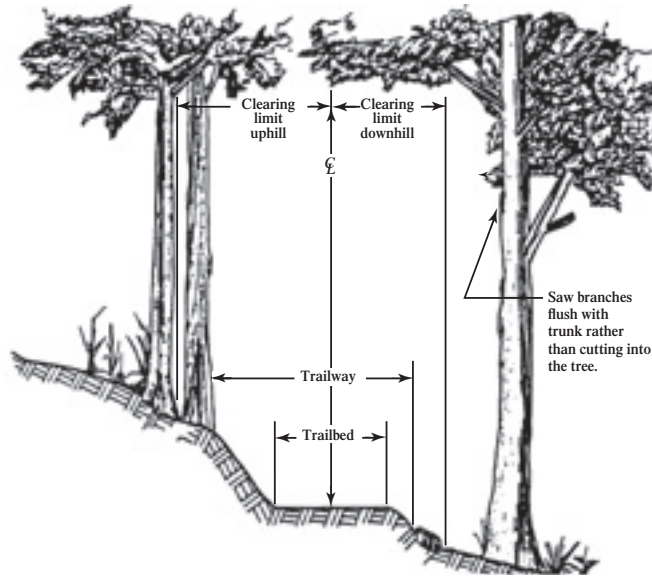

Figure 21—Terms describing the trail corridor clearing limits. You need to understand these terms to clear a trail to specifications.

back and obstacles, such as boulders and fallen trees, are removed from the trail corridor to make it possible to ride or walk on the tread.

The dimensions of the corridor are determined by the needs of the target users and the challenge of the trail. For example, in the Northern Rockies, trail corridors for traditional packstock are cleared 2.5 meters (8 feet) wide and 3 meters (10 feet) high. Hiking trails are cleared 2 meters (6 feet) wide and 2.5 meters (8 feet) high. Check with your local trail manager to determine the appropriate dimensions for each of your trails.

Clearing and Brushing

Working to wipe out your trail is no less than that great nuclear furnace in the sky—Old Sol, the sun. Old Sol and the mad scientist, Dr. Photosynthesis, convert dirt and water into a gravity-defying artifice called a plant. Seasoned trail workers will attest to the singular will and incredible power of plants. No sooner is a trail corridor cleared of plants than new ones rush toward this avenue of sunlight.

Plants growing into trail corridors or trees falling across them are a significant threat to a trail's integrity. Brush is a major culprit. Other encroaching plants such as thistles or dense ferns may make travel unpleasant or even hide the trail completely. If people have trouble traveling the trail tread, they'll move over, usually along the lower edge, or make their own trail. Cut this veggie stuff out (figure 22)!

In level terrain, the corridor is cleared an equal distance on either side of the tread's centerline. For a hiking trail, this means that the corridor is cleared for a distance of 1 meter (3 feet) either side of center. Within 300 millimeters (1 foot) of the edge of the tread, plant material and debris should be cleared all the way to the ground. Farther than 500 millimeters (1.5 feet) from the trail edge, plants do not have to be cleared unless they are taller than 500 millimeters (1.5 feet) or so. Fallen logs usually are removed to the clearing limit.



Figure 22—This trail needs to be brushed. Cut the veggie stuff out.

On moderate to steep sideslopes, a different strategy may be useful. Travel along the lower (outer) edge of the tread is a common cause of tread failure. You can use trailside material to help hold traffic to the center of the tread. A downed log cut nearly flush with the downhill

edge of the trail will encourage travelers to move up to avoid it. Rocks, limbed trees, and the like can all be left near the lower edge of the tread to guide traffic back to the center so long as the guide material doesn't prevent water from draining off the trail (figure 23).



Figure 23—Rocks and logs help to keep the trail in place. Remember, this is a path through nature, not a monument to Attila the Hun.

The key is to make sure that this guide material does not interfere with travel on the center of the tread and does not block drainage. For example, bikers need enough room for their pedals to clear the backslope on one side of the trail and the guide materials on the other.



On the uphill side of the trail, cut and remove material farther from the centerline. For instance, on slopes steeper than 50 percent you may want to cut fallen logs or protruding branches within 2 meters (6½ feet) or more from the centerline (horizontal distance). This is particularly true if you're dealing with packstock because they tend to shy away from objects at the level of their head.

Clearing a *movable corridor* rather than clearing to a fixed height and width takes some thought. Doing so may be difficult for inexperienced crews.

Finally, remember that the scorched earth look created by a corridor with straight edges is not very pleasing to the eye. Work with natural vegetation patterns to feather or meander the edges of your clearing work so you don't leave straight lines. Cut intruding brush back at the base of the plant rather than in midair at the clearing limit boundary. Cut all plant stems close to the ground. Scatter the resulting debris as far as practical. Toss stems and branches so the cut ends lie away from the trail (they'll sail farther through brush as well). Don't windrow the debris unless you really and truly commit to burn or otherwise remove it (and do this out of sight of the trail).

Rubbing the cut ends of trailside logs or stumps with soil reduces the brightness of a fresh saw cut. In especially sensitive areas, cut stumps flush with the ground and cover them with dirt, pine needles, or moss. Rub dirt on stobs or bury them. Here's where you can use your creativity. A carefully trimmed corridor can give a trail a special look, one that encourages users to return.

Some trails may have to be brushed several times a year, some once every few years. Doing a little corridor maintenance when it is needed is a lot easier than waiting until plant growth causes expensive problems.

Removing Trees

Usually, trees growing within the corridor should be removed. Remember that those cute little seedlings eventually grow into pack-snagging adolescent trees. They are a lot easier to pull up by the roots when they are small than they are to lop when they grow up.

Prune limbs close to the tree trunk. For a clean cut, make a shallow undercut first, then follow with the top cut. This prevents the limb from peeling bark off the tree as it falls. Do not use an ax for pruning.

If more than half of the tree needs pruning, it is usually better to cut it down (figure 24). Cut trees off at ground level and do not leave pointed stobs.



Figure 24—Something's wrong with these trees! Cut trees out when they need excessive pruning.

Logging out a trail means cutting away trees that have fallen across it. The work can be hazardous. The size of the trees you are dealing with, restrictions on motorized equipment, and your skill and training determine whether chain saws, crosscut saws, bow saws, or axes are used. Safety first!

You need training to operate a chain saw or a crosscut saw. Your training, experience, and level of certification can allow you to buck trees already on the ground or to undertake the more advanced (and hazardous) business of felling standing trees. Be sure you are properly trained and certified before cutting standing or fallen trees. Using an ax to cut standing or fallen trees poses similar hazards. Some trees may be felled more safely by blasting. Check with a certified blaster to learn where blasting is feasible.

Removing fallen trees is a thinking person's game. The required training will help you think through problems, so we won't relate the details here.

Cut fallen trees out as wide as your normal clearing limits on the uphill side, but closer to the trail on the downhill side. Roll the log pieces off the trail and outside the clearing limits on the downhill side. Never leave them across ditches or waterbar outflows. If you leave logs on the uphill side of the trail, turn or bury them so they won't roll or slide onto the trail.

Sometimes you'll find a fallen tree lying parallel with the trail. If the trunk of the tree is not within the clearing limits and you decide to leave it in place, prune the limbs flush with the trunk. Limbing the tree so it rests on the ground helps the trunk decay faster.

It is hard to decide whether or not to remove *leaners*, trees that have not fallen but are leaning across the trail. If a leaner is within the trail clearing zone, it should be removed. Beyond that, it is a matter of discretion whether a leaner needs to be cut. You need to consider the amount of use on the trail, how long it will be before the trail is maintained again, the soundness of the tree, and the potential hazard the leaner is creating (figure 25). Felling a leaner, especially one that is hung up in other trees, can be very hazardous. Only highly qualified

sawyers should work on leaners. Blasting is another way to remove leaners safely. When in doubt, tie flagging around the leaner and notify your supervisor.

Based on injury statistics, felling standing trees (including snags) is one of the most dangerous activities for trail workers. Do not even consider felling trees unless you have been formally trained and certified. Bringing in a trained sawyer is cheaper than bringing in a coroner.



Figure 25—If you are uncomfortable with your ability to safely cut a tree because of the hazards or your lack of experience, walk away.



Here's how you can make sure your trail has a strong, long-lasting foundation.

Rolling Contour Trails

Constructing contour trails into the sideslope requires excavating the side of the hill to provide a solid, stable trail tread. Stay away from flat areas because water has nowhere to go. Keep grades sustainable by using the half rule and add plenty of grade reversals. Slightly outslowing the tread (about 5 percent) is a must to help move water across the trail.

Full-Bench Construction

Trail professionals almost always prefer *full-bench* construction. A full bench is constructed by cutting the full width of the tread into the hillside and casting the excavated soil as far from the trail as possible (figure 26). Full-bench construction requires more excavation and leaves a larger backslope than partial-bench construction, but the trailbed will be more durable and require less maintenance. You should use full-bench construction whenever possible.

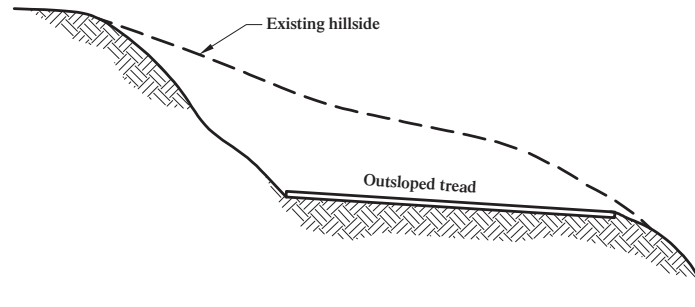

Figure 26—A full-bench trail is constructed by cutting the full width of the tread into the hillside. The tread needs to be outsloped at least 5 percent.

Partial-Bench Construction

Partial-bench construction is another method to cut in a trail, but it takes a good deal of trail-building experience to get this method right. The trail tread will be part hillside and part fill material (figure 27).

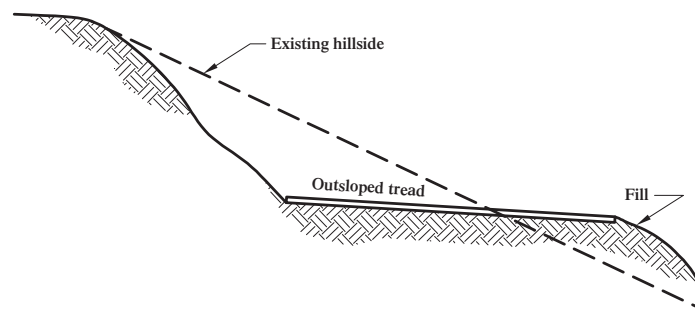

Figure 27—With partial-bench construction, the trail tread is part hillside and part fill material. The tread needs to be outsloped at least 5 percent.

The fillslope needs to be composed from good, solid material like rock or decay-resistant wood. And it has to get compacted evenly—this is the puzzle to solve. Solving Sudoku puzzles doesn't guarantee you'll get this one!

Backslope—The backslope is the excavated, exposed area above the tread surface. The backslope should match the angle of repose of the parent material (the sideslope). You may come across trail specifications calling for 1:1 backslope. This means 1 meter vertical rise to 1 meter horizontal run.

Most soils are stable with a 1:1 backslope. Solid rock can have a steeper 2:1 backslope, while less cohesive soils may need a 1:2 backslope (figure 28).

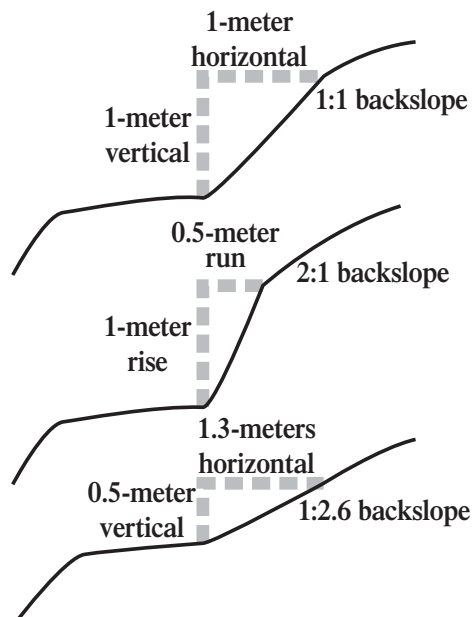

Figure 28—Backslopes are noted as a ratio of vertical rise to horizontal distance, or “rise” to “run.”

Bottom line, angle the backslope until loose material quits falling down onto the trail tread. Stabilize the entire backslope by compacting it with the back of a McLeod.

Stable Backslopes

Look at the surrounding landscape and soil to see areas that are stable. Create a somewhat gentler backslope than you think necessary. Although you will initially expose more raw soil, the chances of your trail remaining stable and revegetating are greater than if you leave a backslope so steep that it keeps sloughing.

One option to reduce backslope excavation is to construct a retaining wall. This can be less obtrusive than huge backslope excavations and more stable if the wall is well constructed.

Fillslope—The fillslope is that area below the tread surface on the downhill side. A full-bench tread will not have any fill on this side of the trail. Fillslopes are critical. Fillslopes often need to be reinforced with retaining or crib walls to keep them from failing. Fillslope failures

are common and will wipe out the trail. That's why most trailbuilders prefer full-bench trails.

Moving Dirt

Looking at construction plans is one thing, but going out and building a rolling contour trail is quite another. Here is a proven method that works even for the complete novice. This procedure is for the actual dirt moving once vegetation has been cleared.

- Place pin flags to keep the diggers on course.
- Straddle a centerline flag and face uphill. Swing your Pulaski or other tool to mark the area to be cleared. Where the tool strikes the hillside will be approximately the top of the backslope. The steeper the slope, the higher the backslope.

Do this at each centerline flag, then scratch a line between the tool strikes. This defines the area to be dug to mineral soil. Clear about the same distance below the flag. Keep the duff handy by placing it uphill. It will be used later. Don't clear more trail than can be dug in a day unless you know it isn't going to rain before you can complete the segment.

- Stand on the trail and work the tread parallel to the direction of travel. Level out the tread and get the right outslope. Don't continue facing uphill when you're shaping the tread, despite the tendency to do so.
- Make sure that the width of the rough tread is about the length of a Pulaski handle. The finished tread will be about right for a good hiking trail.
- Make sure grade reversals and other drainage structures are flagged and constructed as you go.
- Shape the backslope about as steep as the original slope. Backslope ratios are hard to understand. Instead, look at the natural slope and try to match it.
- Round off the top of the backslope, where the backslope meets the trail tread, and the downhill edge of the trail. Keeping these areas smooth and rounded will help water sheet across the trail.
- Walk the trail to check the tread's outslope. If you can feel your ankles rolling downhill, there is too much outslope (figure 29). The outslope should be barely detectable to the eye. A partially filled water bottle makes a good level or you can stand a McLeod on the trail tread—the handle should lean slightly downhill.
- Compact the entire tread, including the backslope, with the back of a McLeod. Don't leave compaction up to trail users. They will only compact the center, creating a rut that funnels water down the middle of the trail.
- Place the duff saved earlier onto the scattered dirt that was tossed downhill. The duff helps naturalize the outside edge and makes the new trail look like it has been there for years.
- Be careful not to create a berm with the duff.

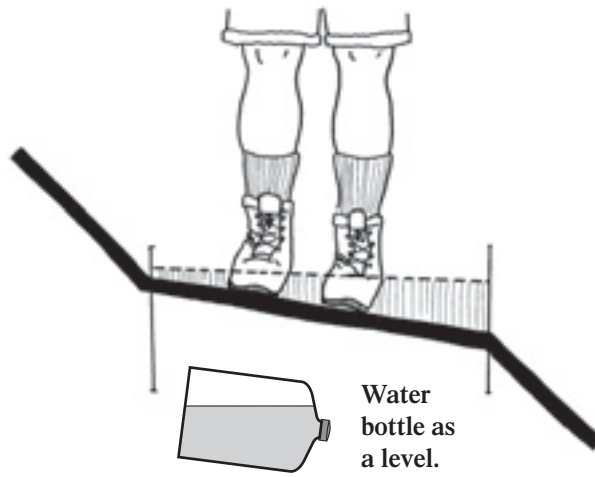
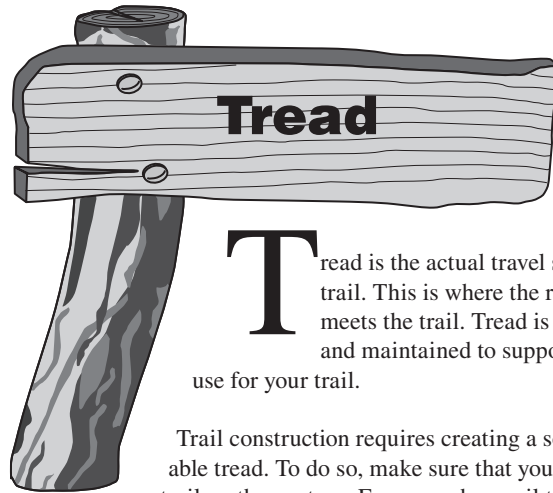

Figure 29—If your ankles start to roll, the tread has too much outslope.



Tread is the actual travel surface of the trail. This is where the rubber (or hoof) meets the trail. Tread is constructed and maintained to support the designed use for your trail.

Trail construction requires creating a solid, sustainable tread. To do so, make sure that you locate the trail on the contour. Forces such as soil type, annual precipitation, and other factors may influence how long the tread remains stable before maintenance is needed.

Soil type and texture have a major influence on soil drainage and durability. Texture refers to the size of individual soil particles. Clay and silt are the soil components with the smallest particles. Small particles tend to be muddy when wet and dusty when dry. Clay and silt don't provide good drainage. Sand is made of large particles that don't bind together at all and are very unstable.

The best soil type is a mixture of clay, silt, and sand. If your soil is lacking any one of these, you can attempt to add what's missing. Knowing the soil types that you will encounter when building trails will help you develop a solid, stable tread. A lot of information on soils can be found at the USDA Natural Resources Conservation Service (<http://soil.usda.gov>) office or at your county extension service office.

Get To Know Your Soil With the Ribbon Test

Roll a handful of moist soil into a tube shape with both hands. Squeeze it between your thumb and forefinger to form the longest and thinnest ribbon possible.

Texture	Feel	Ribbon
Sand	Grainy	Can't form a ribbon
Loam	Soft with some graininess	Thick and very short
Silt	Floury	Makes flakes rather than a ribbon
Sandy Clay	Substantial graininess	Thin, fairly long—50 to 76 mm (2 to 3 inches)—holds its own weight
Clay	Smooth	Very thin and very long—76 mm (3 inches)

The tread surface should match the intended use. Easier trails should have a smooth tread surface. Backcountry trails can be rougher and more challenging. Leaving some obstacles in the trail helps slow down users and reduce conflict.

Tread is also the travel surface on structures such as turnpikes and punchon. Tread, whenever elevated, should be slightly crowned (higher in the center than on either side) to drain better.

Outsloping

An outsloped tread is one that is lower on the outside or downhill side of the trail than it is on the inside or bankside. Outsloping lets water sheet across the trail naturally. The tread should be outsloped at least 5 percent.

Loss of outslope is the first maintenance problem that develops on all trails. If you can do nothing else when budgets are tight, reestablish the outslope. Doing so pays big dividends.

Removing Roots and Stumps

Removing roots and stumps is hard work. Explosives and stump grinders are good alternatives for removing stumps, but chances are you'll have to do the work by hand. Often, a sharpened pick mattock or

Pulaski is used to chop away at the roots. If you are relying on some type of winch system to help you pull out the stump, be sure to leave the stumps high enough to give you something to latch onto for leverage.

Not all roots and stumps are problems. You should not have to remove many large stumps from an existing trail. Before you remove a stump, consider whether other crews might have left it to keep the trail from creeping downhill.

Rule of Thumb for Roots

- If roots are perpendicular to the tread, fairly flush, and not a tripping hazard, leave them.
- Remove roots that are parallel with the tread. They help funnel water down the trail and create slipping hazards.
- Route your trail above large trees. Building below trees undermines their root systems—eventually killing the trees.

Rock Removal

Rock work for trails ranges from building rock walls to blasting solid rock. These tasks involve specialty work. When rock needs to be removed, a good blaster can save a crew an astounding amount of work. When rock needs to be used, someone building a rock retaining wall

may be a true artisan, creating a structure that lasts for centuries. Rock work requires good planning and finely honed skills.

Brains First, Muscle Last

Remember that the two most common injuries in rock work are pinched (or smashed) fingers and tweaked (or blown out) backs. Both sets of injuries are a result of using muscles first and brains last. High-quality rock work is almost always a methodical, even tedious, task. Safe work is **ALWAYS** faster than taking time out for a trip to the infirmary.

The secret to moving large rocks is to think first. Plan where the rock should go and anticipate how it might roll. Be patient—when rocks are moved in a hurry they almost always end up in the wrong place. Communicate with all crewmembers about how the task is progressing and what move should occur next.

Tools of the trade include:

- Lots of high-quality rockbars. Don't settle for the cheap digging bars. You need something with high tensile strength.
- Pick mattock.
- Sledge hammer.
- Eye protection, gloves, and hardhat. Don't even think of swinging a tool at a rock without wearing the required personal protective equipment.
- Gravel box, rock bag, rucksack, rock litter—all useful for carrying rocks of various sizes.

- Winch and cable systems. Some rocks can be dragged or lifted into place.
- All sorts of motorized equipment, including rock drills and rock breakers.

Blasting can help remove rocks or greatly reduce their size. Careful blasting techniques can produce gravel-sized material. Motorized equipment can be used to split boulders or to grind down obstacles in the tread. Chemical expansion agents can be poured into holes drilled into large rocks, breaking them without explosives. Drills and wedges can be used to quarry stone for retaining walls or guide structures. Devices like the Boulder Buster, Magnum Buster, and BMS Micro-Blaster crack rocks without explosives and can be used by persons who are not certified blasters.

Your specific trail maintenance specifications may call for removing embedded rocks. Use good judgment here. Often, large rocks are best removed by blasting. Other solutions include ramping the trail over them, or rerouting the trail around them.

Rocks should be removed to a depth of at least 100 millimeters (4 inches) below the tread surface, or in accordance with your specific trail standards. Simply knocking off the top of a rock flush with the existing tread may leave an obstacle after soil has eroded around the rock.

Rockbars work great for moving medium and large rocks. Use the bars to pry rocks out of the ground and guide them off the trail. When crewmembers have two or three bars under various sides of a large rock, they can apply leverage to the stone and virtually float it to a new location with a rowing motion. Use a small rock or log as a fulcrum for better leverage.

It may seem like fun at the time, but avoid the temptation to kick a large stone loose. When rocks careen down the mountainside they may knock down small trees, gouge bark, wipe out trail structures, or start rockslides.

Even worse, an out-of-control rock might cross a trail or road below you, hitting someone. If there is any possibility that people might be

below while rocks are being moved, close the trail or road, or post lookouts in safe locations to warn travelers.

You might construct a barrier of logs anchored by trees before trying to move the rock, preventing it from gaining momentum. Once a rock is moving, do not try to stop it.

When you need to lift rocks, be sure to keep your back straight and lift with the strong muscles of your legs. Sharing the burden with another person can be a good idea.

To load a large rock into a wheelbarrow, lean the wheelbarrow back on its handles, roll the rock in gently over the handles (or rocks placed there) and tip the wheelbarrow forward onto its wheels. Keep your fingers clear any time you deal with rocks.

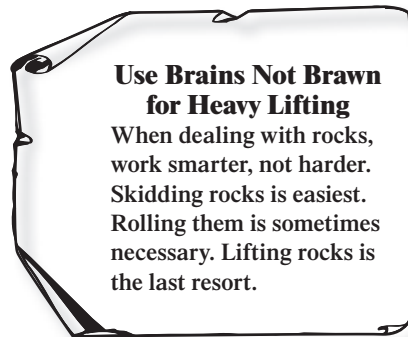

Often small rocks are needed for fill material behind crib walls, in turnpikes and cribbed staircases, and in voids in sections of trail built in talus (rock debris). Buckets and wheelbarrows are handy here. So are canvas carrying bags. If you are part of a large crew, handing rocks person-to-person often works well. Remember,

it's usually not a good idea to twist your upper body while you are holding a heavy rock.

Tread Maintenance

A solid, out-sloped surface is the objective of trail maintenance. Remove and scatter berm material that collects at the outside edge

of the trail. Reshape the tread and restore the outslope. Maintain the tread at the designed width. Remove all the debris that has fallen on the tread—the sticks and stones and candy wrappers. Maintenance includes removing obstacles such as protruding roots and rocks on easier trails. It also means repairing any sections that have been damaged by landslides, uprooted trees, washouts, or boggy conditions. Compact all tread and sections of backslope that were reworked.

Slough and Berms

On hillside trails, *slough* (pronounced *sluff*) is soil, rock, and debris that has moved downhill to the inside of the tread, narrowing the tread. Slough needs to be removed (figure 30). Doing so is hard work. Slough that doesn't get removed is the main reason trails "creep" downhill.

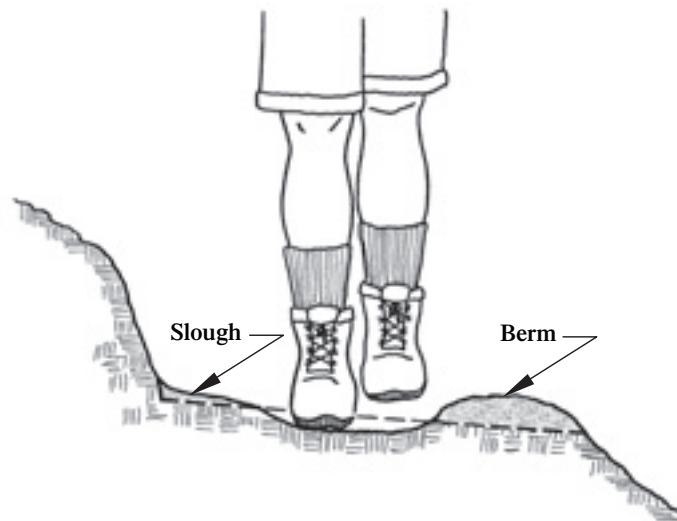

Figure 30—Remove the slough and berm, leaving the trail outsloped so water will run off.

Loosen compacted slough with a mattock or Pulaski, then remove the soil with a shovel or McLeod. Reshape the tread to restore its outslope. Avoid disturbing the entire backslope unless it is absolutely necessary to do so. Chop off the toe of the slough and blend the slope back into the hillside. Remember to compact the tread thoroughly.

Berms are made of soil that has built up on the outside of the tread, forming a barrier that prevents water from sheeting off. Berms form when water erodes trail tread that wasn't compacted during construction, depositing it on the edge of the trail. Water runs down the tread, gathering volume and soil as it goes. Berm formation is the single largest contributor to erosion of the tread. Removing berms is always the best practice.

Berms may form a false edge, especially when berms are associated with tread creep. False edge is unconsolidated material, often including significant amounts of organic material, that can't bear weight. This is probably the least stable trail feature on most trails and a major contributor to step-throughs and wrecks.

If berms persist, an insloped turn may be an option. Essentially this is a turn with a built-up berm. Insloped turns will improve trail flow and add an element of fun on off-highway vehicle and mountain bike trails. Special attention needs to be placed on creating proper drainage. This requires a high level of trail-building experience and a good understanding of waterflow.

Tread Creep

Does your contour trail display:

- Exposed bedrock or roots along the uphill side of the tread?
- Tread alignment that climbs over every anchor point and drops before climbing to the next anchor point?
- Pack bumpers (downhill trees scarred by packstock panniers)?

All three are indications that the tread surface has been eroded and compacted by travel along the outside edge. Insidious tread creep is at work. Tread creep should be stopped or the trail will eventually become very difficult or dangerous to travel (figure 31).



Figure 31—A classic case of tread creep. This trail needs help now because the tread is moving downhill.

What causes tread creep? The answer is simple. Most livestock, wheeled traffic, and some hikers have a natural tendency to travel the outside edge of sidehill trails. Sloughing makes the edge of the trail the flattest place to walk. Backslopes that are too steep may slough material onto the tread, narrowing the trail. The trail becomes too narrow. The result is that traffic travels closer to the outside edge (figure 32). Your job is to bring the trail back uphill to its original location and keep it there.

Causes of Trail Creep

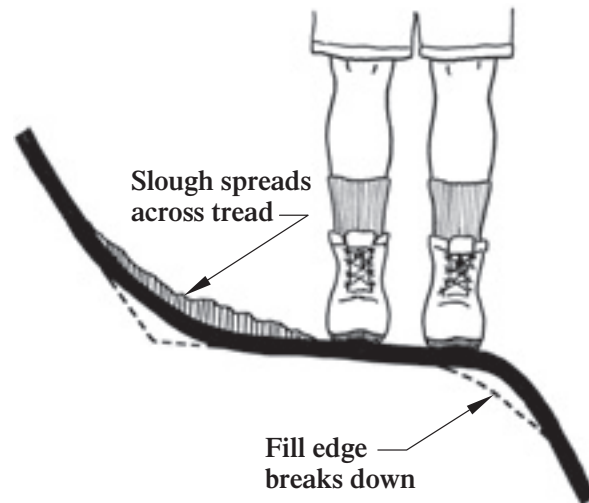

Figure 32—Tread creep at work—sloughing and soft fillslopes.

To fix tread creep, cut the backslope properly, remove slough, and reestablish the 5-percent outslope. Take advantage of large stationary objects (guide structures) to prevent animals and people from walking along the edge. Trees, the ends of logs, rocks, and stumps that are left close to the downhill edge of the trail will keep traffic walking closer to the middle.

Tread material between guide structures might creep downhill, creating a situation where the trail climbs over every tread anchor and descends again, a *daisy chain*. At the bottom of these dips, water and sediment collect. This is the weakest portion of the tread and the most prone to catastrophic failure. The tread can be so soft that packstock may punch completely through the tread (called a step-through) or bicycles and motorcycles may collapse the edge, leading to bad wrecks.

Where soil is in short supply, you may have to install a short retaining wall and haul in tread material. The tread should be benched back into the slope in the original alignment. Guide structures should be installed on the outside edge of the tread to keep traffic toward the center.

A note on guide structures: If you use a rock, be sure it is big enough that at least two-thirds of it may be buried so people or bears won't roll it away (figure 33). Guide structures should be placed at random distances so they don't act like a wall to trap water on the tread. You might need to make the trail a little wider to accommodate the guide structure.

Stabilizing Tread Creep

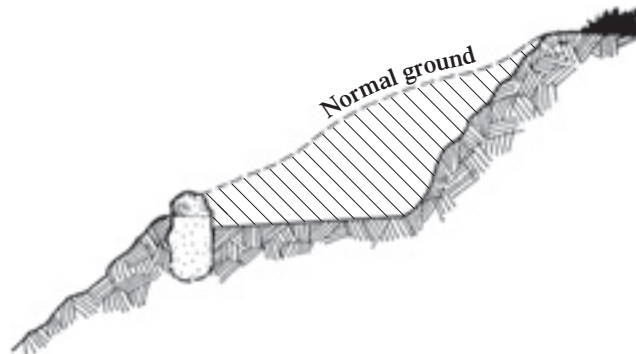
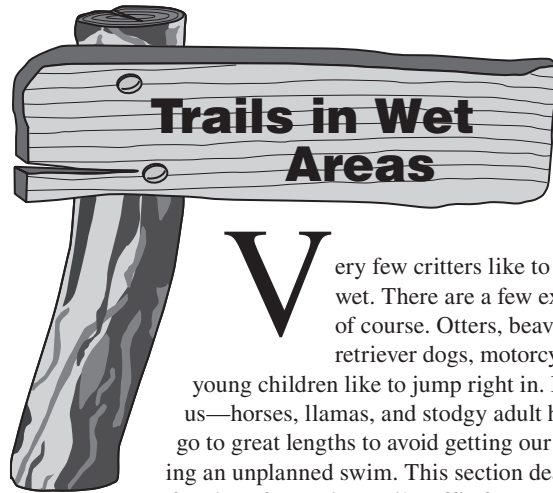

Figure 33—Guide rock properly installed to help prevent tread creep. Do not create a continuous barrier that impedes water drainage.





Very few critters like to get their feet wet. There are a few exceptions, of course. Otters, beavers, goofy retriever dogs, motorcyclists, and young children like to jump right in. But the rest of us—horses, llamas, and stodgy adult hikers—often go to great lengths to avoid getting our feet wet or taking an unplanned swim. This section deals with a range of options for getting trail traffic from one side of wet ground to the other. See “Wetland Trail Design and Construction” (Steinholtz and Vachowski 2007) for additional information.

Because nearly every technique for fixing trails in boggy areas is expensive and needs to be repeated periodically, relocating the problem section of trail should be considered first. Scouting for suitable places to relocate trails and reviewing soil maps is time well spent. The alternative route should traverse the sideslope for better drainage. Don't reroute a problem section of trail to another boggy piece of ground. If you do, the result will be two problem trail sections instead of one.

Moving up in cost and complexity, two types of structures—turnpikes and puncheon—are commonly constructed to keep trails dry through wet or boggy areas. Using geosynthetics in combination with these techniques can result in a better tread with less fill. Rock armoring is popular in some areas where hardened trails are needed.

A trail bridge may be needed in situations where long spans will be high above the ground or for crossing streams. Bridges require special designs fitted to each type of use. Engineering approval is needed before constructing either a standard or specially designed bridge.

Boardwalks are common in some parts of the country, particularly in parts of Alaska and in the Southeast. They can range from fairly simple structures placed on boggy surfaces to elevated boardwalks over marshes or lake shores, such as those found at some interpretive centers (figure 34).



Figure 34—This boardwalk relies on pilings for support. Helical earth anchors also could be used to support the structure.

Geosynthetics

Geosynthetics are synthetic materials (usually made from hydrocarbons) that are used with soil or rock in many types of road and trail construction. Geosynthetics offer alternatives to traditional trail construction practices and can be more effective in some situations.

Geosynthetics perform three major functions: separation, reinforcement, and drainage. Geosynthetic materials include geotextiles (construction fabrics), geonets, sheet drains, and geocells. All these materials become a permanent part of the trail and must be covered with soil or rock. If the material is exposed, it can be damaged by trail users and may cause users to slip or trip.

Geotextiles (figure 35) are the most widely used geosynthetic material. Sometimes they are called construction fabrics. They are made from long-lasting synthetic fibers bonded to form a fabric that is used primarily for separation and reinforcement over wet, unstable soils. They have the tensile strength needed to support loads and can allow water, but not soil, to seep through.

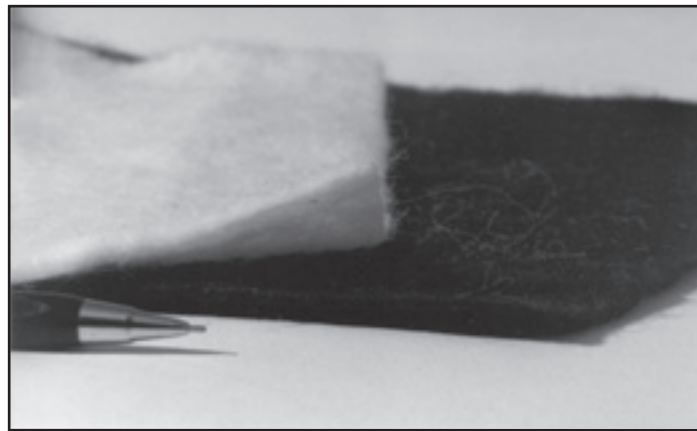

Figure 35—Felt-like geotextiles are easier to work with than heat-bonded, slit-film, or woven products with a slick texture.

Geotextiles are often used when constructing turnpikes or causeways. The geotextiles separate the silty, mucky soil beneath the fabric from the mineral, coarse-grained, or granular soil placed as tread material on top of the geotextile. The importance of separation cannot be over-emphasized. It takes only about 20 percent silt or clay before mineral soil takes on the characteristics of mud—and mud is certainly not

what you want for your tread surface. Most geotextiles commonly used in road construction work are suitable for trail turnpikes. The fabric should allow water to pass through, but have openings of 0.3 millimeter (0.01 inch) or smaller that silt can't pass through.

Geotextiles need to be carefully sized, trimmed, and sometimes fastened down before they are covered with fill. The fabric needs to be overlapped at joints and trimmed to fit over bedrock. The fabric must be covered with tread material.

Some geotextiles are sensitive to ultraviolet light. They decompose readily when exposed to sunlight. Always store unused geotextile in its original wrapper.

Geonets or **geonet composites** (figure 36) have a thin polyethylene drainage core that is covered on both sides with geotextile. They are used for separation, reinforcement, and drainage. Because geonets have a core plus two layers of geotextile, they provide more reinforcement than a single layer of geotextile.

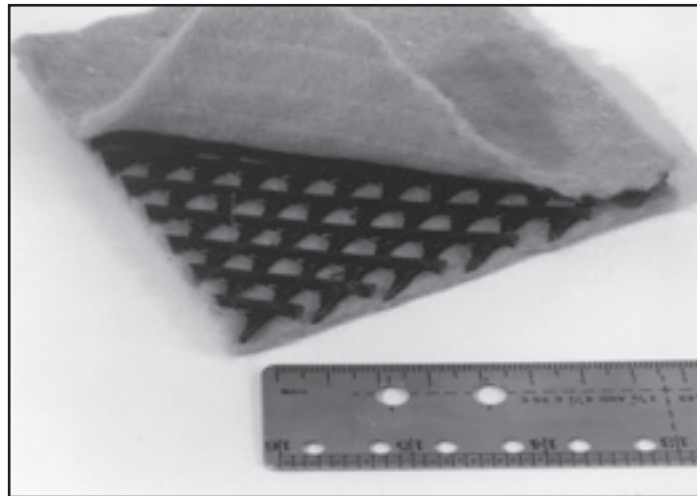

Figure 36—The net-like core of geonet allows water to drain through it.

Sheet drains are made with a drainage core and one or two layers of geotextile. Usually, the core is made of a polyethylene sheet shaped like a thin egg crate. The core provides an impermeable barrier unless it has been perforated by the manufacturer. When used under the trail tread material, sheet drains provide separation, reinforcement, and drainage. Because they have greater bending strength than geotextiles or geonets, less tread fill may be needed.

Sheet drains or geonets can be used as drainage cutoff walls (figure 37). If the trail section is on a sideslope where subsurface water saturates the uphill side of the trail, a cutoff wall can be constructed to intercept surface and subsurface moisture, helping to drain and stabilize that section of trail.

Drainage Cutoff Walls

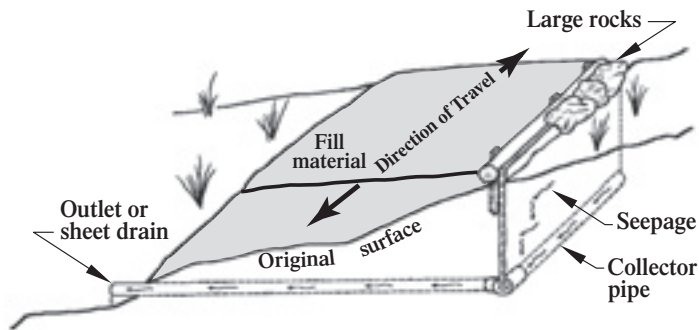

Figure 37—A sheet drain or geonet can be used to intercept seepage.

Geocells usually are made from polyethylene strips bonded to form a honeycomb structure. Each cell is backfilled and compacted (figure 38). Geocells are good for reinforcement, reduce the amount of fill material required, and help hold the fill in place. Geocell usually has geotextile underneath it for separation from saturated soils. The grids need to be covered and compacted with at least 76 millimeters (3 inches) of tread material so they will never be exposed. Exposed geocells present a substantial hazard to foot traffic and vehicles, which will lose traction.



Figure 38—Geocells are good for tread reinforcement and help hold fill in place.

Rock Underdrains

Rock underdrains (often called *French drains*) are ditches filled with gravel. They can be used to drain a spring or seep running across the trail. Wrap the gravel with geotextile to help prevent silt from clogging the rock voids. Start with larger pieces of rock and gravel at the bottom, topping off with smaller aggregate (figure 39). Finish the drain with 150 millimeters (6 inches) of tread material so that the surface matches the rest of the trail.

Rock Underdrain or French Drain

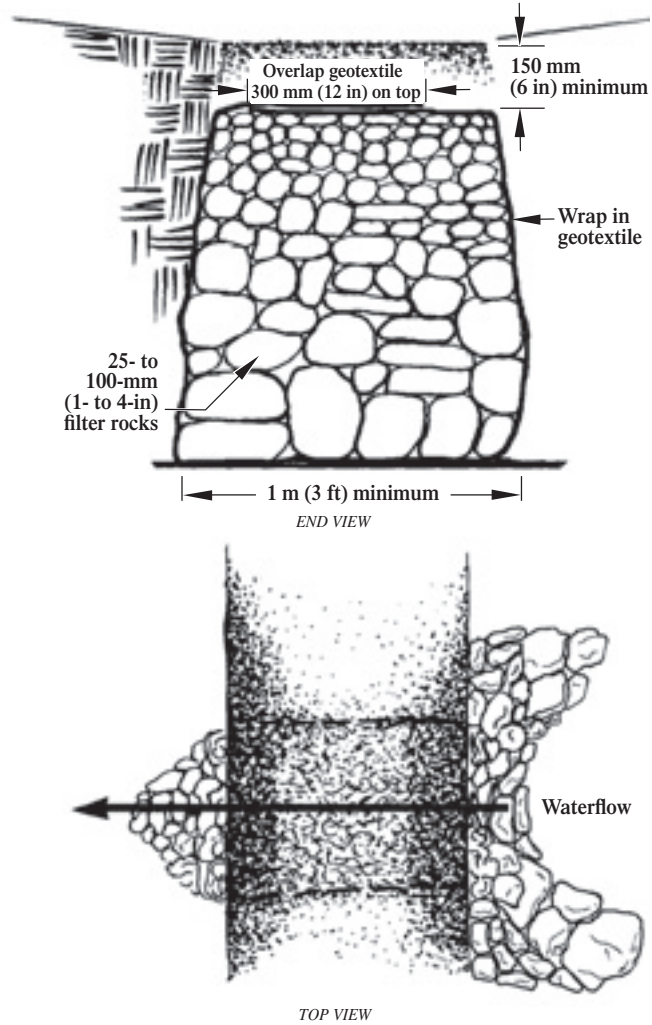

Figure 39—Wrapping rock underdrains with geotextile helps prevent them from clogging. Rock underdrains are used to drain low-flow springs and seeps.

Turnpikes

Turnpikes elevate a trail above wet ground. The technique uses fill material from parallel side ditches and from areas offsite to build up the trail base so it is higher than the water table. Turnpike construction can provide a stable trail base in areas with a high water table and fairly well- to well-drained soils. Turnpikes are practical for trail grades up to 10 percent (figure 40).

Turnpike With Leadoff Ditch

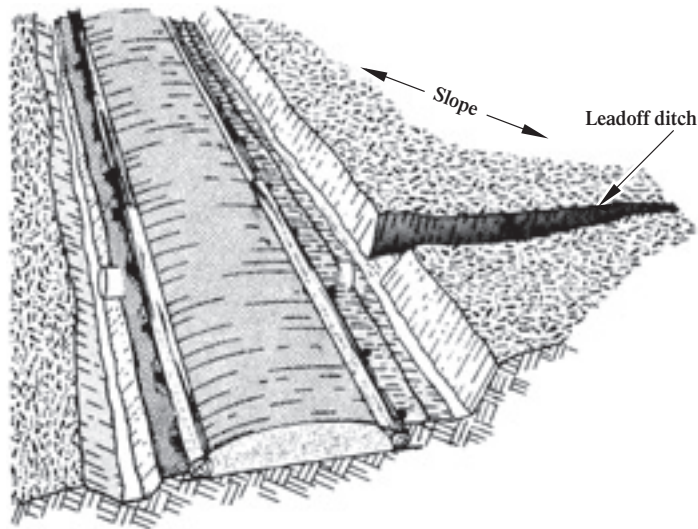

Figure 40—Turnpikes raise a trail above wet ground.

A turnpike should be used primarily in flat areas with wet or boggy ground that have up to 20-percent sideslope. Turnpikes are easier and cheaper to build than puncheon and may last longer.

Finding Fill

Often you need fill material to construct turnpikes. Look for a site that has suitable tread material close to the work site. This is called a borrow pit.

Good places for a borrow pit include:

- Creek bottoms that are replenished by storms and seasonal waterflow
- Bases of slopes or cliffs where heavy runoff or gravity deposits sand and gravel

Don't destroy aquatic or riparian habitat with your pit. Rehabilitate the pit when you're done. Grade the pit out to natural contours with topsoil and debris, then revegetate.

Begin your turnpike by clearing the site wide enough for the trail tread plus a ditch and retainer log or rocks on either side of the trail tread. Rocks, stumps, and stobs that could rip geotextiles or that protrude above the turnpike tread should be removed or at least cut below the final base grade.

Ditch both sides of the trail to lower the water table. Install geotextile or other geosynthetic materials and retainer rocks or logs. Geotextile and geocell should go under any retainer rocks or logs (figure 41). Use high-quality tread material as fill above the geotextile.

Firm mineral soil, coarse-grained soils or granular material, or small, well-graded angular rocks are needed for fill. Often gravel or other well-drained material must

be hauled in to surface the trail tread. If good soil is excavated from the ditch, it can be used as fill. Fill the trail until the crown of the trail tread is 50 millimeters (2 inches) or has a minimum 2-percent grade above the retainers. It doesn't hurt for the fill to be a little too high to begin with, because it will settle.

Geotextile Placement

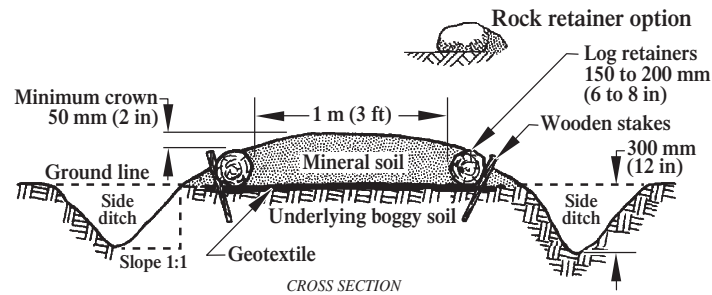

Figure 41—Place geotextile under the retainer logs or rocks before staking the geotextile in place.

Construct a dip or a drainage structure at each end of the turnpike where necessary to keep water from flowing onto the structure. Keep the approaches as straight as possible coming onto a turnpike, to minimize the chance that stock or motorbike users will cut the corners and end up in the ditches. Turnpike maintenance, especially recrowning, is particularly important the first year after construction; the soil will have settled then. Make sure the ditches are cleaned out and are deep enough to drain the turnpike (figure 42).



Figure 42—Turnpike maintenance includes recrowning the tread, cleaning out the ditches, and making sure the ditches are deep enough.

An alternative method, one that not only provides separation between good fill and clay but also keeps a layer of soil drier than the muck beneath, is called encapsulation, or the *sausage encapsulation technique* (figure 43). Excavate 250 to 300 millimeters (10 to 12 inches) of muck from the middle of the turnpike. Lay down a roll of geotextile the length of the turnpike. The geotextile should be wide enough to fold back over the top with a 300-millimeter (1-foot) overlap. Place 150 millimeters (6 inches) of good fill, or even rocks, on top of the single layer of geotextile, then fold the geotextile back over the top and continue to fill with tread material. Rocks or logs can be used for retainers. Rocks last longer.

Sausage or Encapsulation Technique

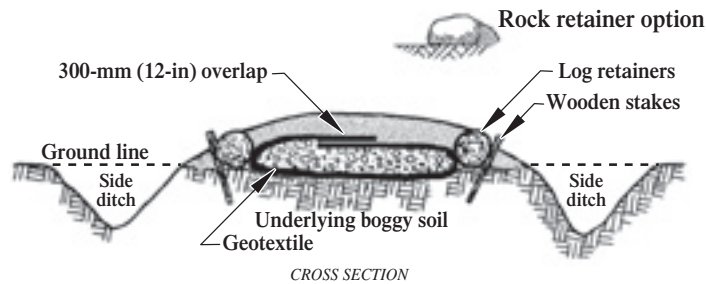

Figure 43—Sausage encapsulation is another way to raise a trail above wet areas.

If you use logs, they should be at least 150 millimeters (6 inches) in diameter and peeled. Lay retainer logs in one continuous row along each edge of the trail tread. The logs can be joined by notching them (figure 44). In some species, notching may cause the logs to rot faster. Anchor the logs with stakes (figure 45) or, better yet, large rocks along the outside. Anchors are not needed on the inside, because the fill and surfacing will hold the retainer logs.

The most important considerations are to keep the water level below the trail base and carry the water under and away from the trail at frequent intervals.

Notched Retainer Log

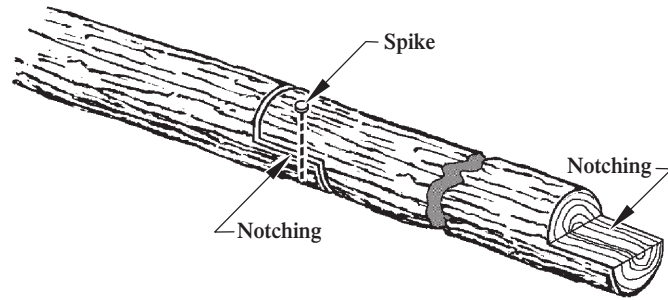

Figure 44—Retainer logs are joined with spikes.

Sapling Stake

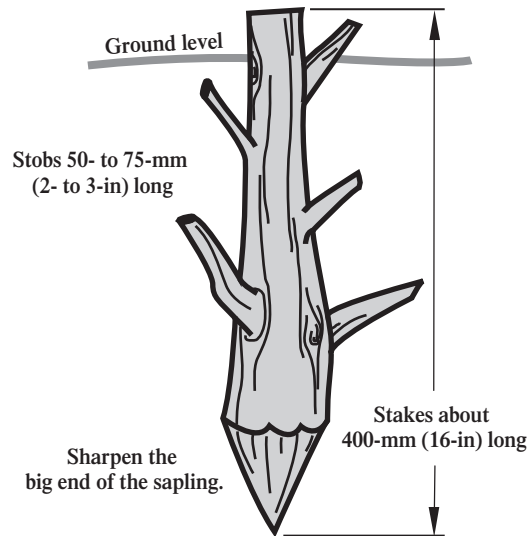

Figure 45—Try this old Alaska trick if your stakes tend to work up out of boggy ground.

Turnpikes Without Ditches

A turnpike without ditches is sometimes called a *causeway*. These structures are viable alternatives where a hardened tread is needed and groundwater saturation is not a problem. Turnpikes without ditches have been used successfully throughout the Sierra Nevada and elsewhere to create an elevated, hardened tread across seasonally wet alpine meadows. The surface can also be reinforced with large stones, called armoring, paving, or flagstone. Often multiple parallel paths are restored and replaced with a single causeway (figure 46). These structures can create less environmental impact than turnpikes with ditches because they do not lower the water table. The risk is that in highly saturated soils the turnpike without ditches could sink into the ground, a problem that geotextile can help prevent.

Turnpikes Without Ditches

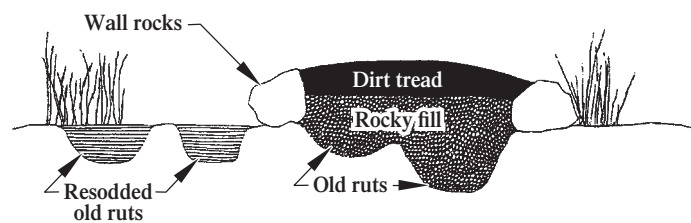

Figure 46—Turnpikes without ditches, sometimes called causeways, create an elevated, hardened tread across seasonally wet areas and can replace multiple parallel paths.

Puncheon

When the ground is so wet the trail cannot be graded and there's no way to drain the trail, use puncheon.

Puncheon is a wooden walkway used to cross bogs or deep muskeg, to bridge boulder fields, or to cross small streams (figure 47). It can be used where uneven terrain or lack of tread material makes turnpike construction impractical. Puncheon is also preferred over turnpikes where firm, mineral soil cannot be easily reached. Puncheon can be supported on muddy surfaces better than a turnpike, which requires effective drainage.

Puncheon

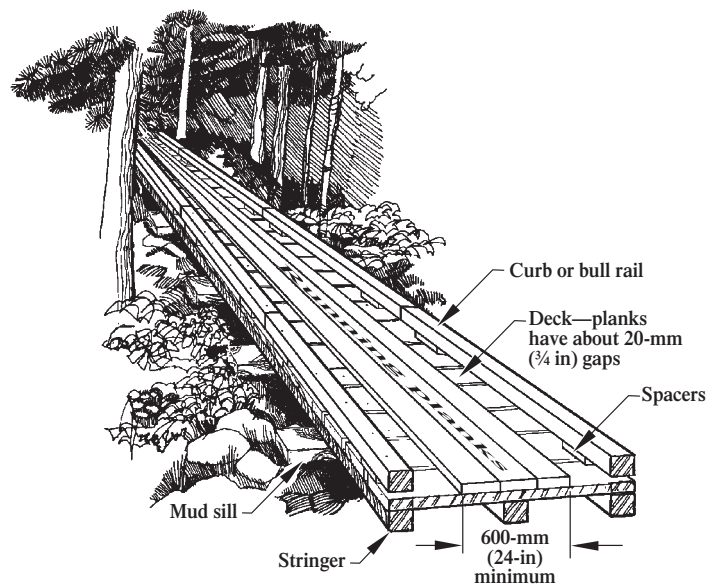

Figure 47—Puncheon is a wooden walkway used when trails cross bogs, deep muskeg, large boulder fields, or small streams.

Puncheon resembles a short version of the familiar log stringer trail bridge. It consists of a deck or flooring made of sawed, treated timber or native logs placed on stringers to elevate the trail across wet areas that are not easy to drain. Puncheon that is slightly elevated is termed standard puncheon (figure 48).



Figure 48—Standard puncheon is slightly elevated above the ground.

Here's how to build puncheon. First of all, the entire structure must extend to solid mineral soil so soft spots do not develop at either end. Approaches should be straight for at least 3 meters (10 feet) coming up to the puncheon. Any curves either approaching or on the puncheon add to the risk of slipping, especially for stock, mountain bike riders, and motorcycle riders.

To begin construction, install mud sills to support the stringers. Mud sills can be made of native logs, treated posts, short treated planks, or precast concrete parking lot wheel blocks. The mud sills are laid in trenches at both ends of the area to be bridged at intervals of 1.8 to 3 meters (6 to 10 feet, figure 49). They are about two-thirds buried in firm ground. If firm footing is not available, use rock and fill to solidify the bottom of the trench, increase the length of the sill log to give it better flotation, or use more sills for enough flotation. Enclosing rock and fill in geotextile minimizes the amount of rock and fill required. For stability, especially in boggy terrain, the mud sills should be as long as practical, up to 2.5 meters (8 feet) long.

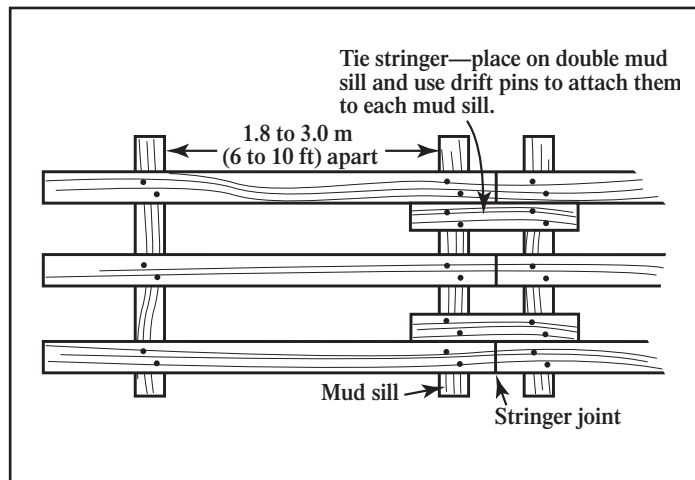

Figure 49—Proper layout of puncheon, showing mud sills and stringers.

Stringers made from 200-millimeter- (8-inch-) diameter peeled logs or treated timbers are set on top of the mud sills. They should be at least 3 meters (10 feet) long and about the same length and diameter. Stringers also need to be level with each other so the surface of the puncheon will be level when the decking is added. Two stringers are adequate for hiking trails, but for heavier traffic, such as packstock, three stringers are recommended.

Notch the mud sills, if necessary, to stabilize the stringers and to even out the top surfaces (figure 50). To hold the stringers in place, toenail spikes through the stringers to the mud sills or drive No. 4 rebar through holes in the stringers.

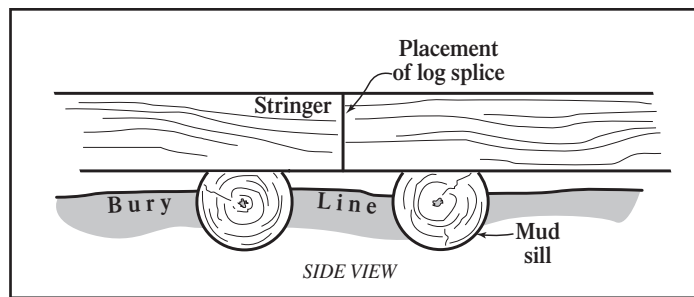

Figure 50—When using logs, notch the mud sill—not the stringer. Don't notch the sill more than one third of its diameter.

Next comes the decking. Decking pieces are fastened perpendicular to the stringers. The decking thickness will vary, depending on the loads the structure will need to support. Decking can be as short as 460 millimeters (18 inches) for a limited-duty puncheon for hikers. For stock or ATV use, decking should be 1.2 to 1.5 meters (4 to 5 feet) wide.

Do not spike decking to the center stringer, if you have one, because center spikes may work themselves up and become obstacles. Leave at least a 20-millimeter (3/4-inch) gap between decking pieces to allow water to run off (figure 51). Decking should be placed with tree growth rings curving down. This encourages water to run off rather than soak in and helps to prevent cupping.

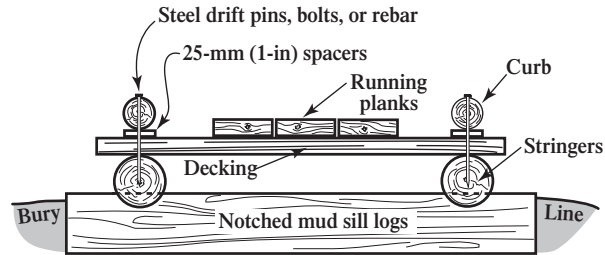

Figure 51—Place the stringers far enough apart to support the full width of the decking.

Running planks are often added down the center for stock to walk on. Often the running planks are untreated because horseshoes wear down the plank before wood has a chance to rot. Do not leave gaps between running planks because they can trap mountain bike or motorcycle wheels.

Curbs, also called bull rails, should be placed along each side of the puncheon for the full length of the structure to keep traffic in the center. To provide for drainage, nail spacers between the curb logs and the decking.

Finally, a bulkhead (sometimes called a backing plate) needs to be put at each end of the structure to keep the stringers from contacting the soil (figure 52). If the plate stays in place, do not spike it to the ends of the stringers. Spiking causes the stringers to rot faster.

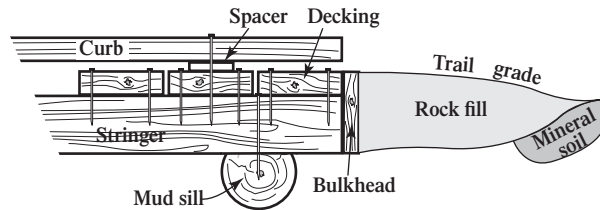

Figure 52—Place a bulkhead or backing plate at each end of the puncheon. Approaches should have a rising grade so water will not run onto the structure.

Subsurface Puncheon

Subsurface puncheon is used in standing water or bogs. It is constructed with mud sills, stringers, and decking flush with or under the wetland's surface. This design depends on continual water saturation for preservation (figure 53). Moisture, air, and favorable temperatures are needed for wood to rot. Remove any one of these and wood won't rot. A good rule for reducing rot is to keep the structure continually dry or continually wet. Totally saturated wood will not rot because no air is present. Cover the surface between the curb logs with a layer of gravel, wood chips, or soil to help keep everything wet (figure 54).

Subsurface Puncheon With Covered Tread Surfacing

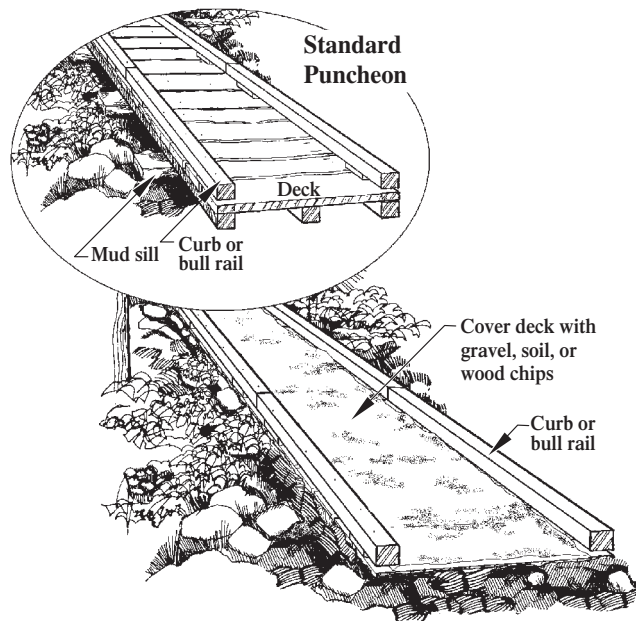

Figure 53—Cover the tread surface between the curb rails with gravel, wood chips, or soil to keep everything wet, preventing decay.



Figure 54—Subsurface puncheon covered with soil and rock.

Corduoy

Corduoy is basically a primitive type of puncheon. It consists of three or more native logs laid on the ground as stringers with logs laid side-by-side across them and nailed in place (figure 55). Corduoy should always be buried, with only the side rails exposed. Corduoy is notorious for decaying quickly and consuming large amounts of material. It should be used only as a temporary measure and is not recommended for new construction. The use of corduoy may indicate that your trail has been poorly sited.

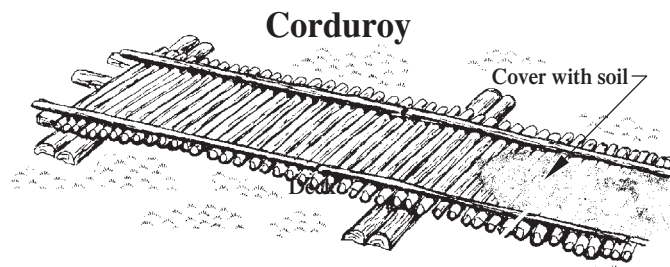
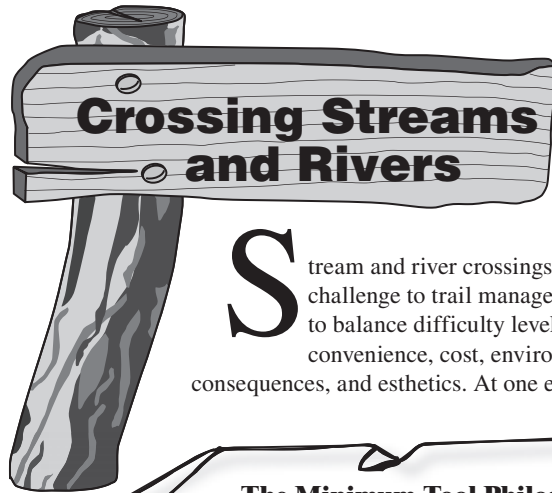

Figure 55—Corduoy should be considered a temporary fix until a more permanent structure can be installed.



Crossing Streams and Rivers

Stream and river crossings present a challenge to trail managers who need to balance difficulty levels, safety, convenience, cost, environmental consequences, and esthetics. At one end of the use

The Minimum Tool Philosophy

The minimum tool philosophy suggests that we get the job done with the least long-term impact while still meeting management objectives. A few minimum tool questions for crossings are:

- Do we really need a bridge here? Do we really need to cross here early in the spring?
- Will someone be killed or injured if we don't provide an easier crossing?
- Is this really the best place to cross this stream?
- What alternatives do we have to cross this stream, including not crossing it at all?
- Can we afford this crossing?
- What are the environmental and social consequences of a given type of crossing here?
- Can we commit to long-term inspections and maintenance?
- Who will really care if we don't build (or replace) a bridge?

It's a wonderful thing to keep one's feet dry, but keeping those feet dry in the backcountry is expensive.

spectrum, a bridge can allow people with disabilities, toddlers, and users who are new to the outdoors to experience the trail with little risk. But bridges are expensive. Wilderness visitors who expect a challenge may prefer a shallow stream ford. During high water, these folks may opt for a tightrope walk across a fallen log. Each kind of water crossing has consequences for the recreation experience and the lands being accessed. Choose wisely from the spectrum of options before committing present and future resources to any given crossing.

Shallow Stream Fords

A shallow stream ford is a consciously constructed crossing that will last for decades with a minimum of maintenance (barring major floods) and will provide a relatively low challenge to users.

The idea behind a shallow stream ford is to provide solid footing at a consistent depth from one bank to the other (figure 56). Most fords are designed to be used just during low to moderate flows. A ford for hikers and packstock, such as llamas and pack goats, should be no deeper than 400 to 600 millimeters (16 to 24 inches, about knee high) during most of the use season. A horse ford shouldn't be deeper than 1 meter (39 inches).

Fords should be located in wider, shallower portions of the stream. The approaches should climb a short distance above the typical high water line so that water isn't channeled down the tread (figure 57). Avoid locations where the stream turns, because the water will undercut approaches on the outside of a turn.

The tread in the ford should be level, ideally made of rock or medium-sized gravel that provides solid footing. The plan is to even out the waterflow through the ford so the gravel-sized material isn't washed away, leaving only cobble or boulders. Make sure you don't block passage for fish and other aquatic organisms.

Shallow Stream Ford

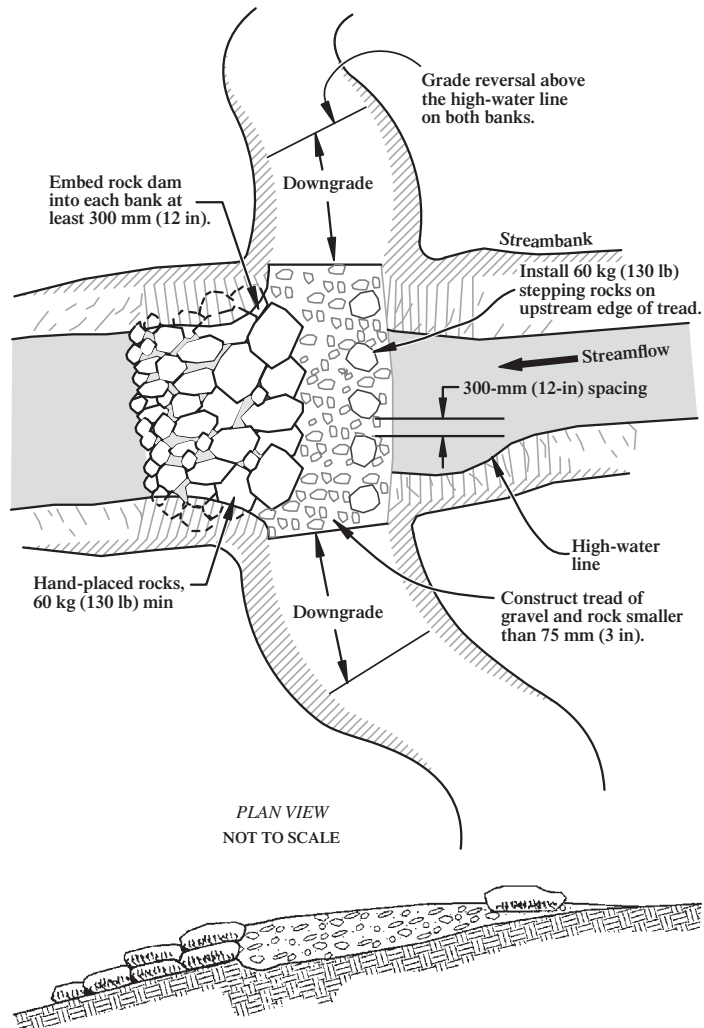

Figure 56—Build fords when the water is low. Place stepping stones for hikers.



Figure 57—Fords should be established in wider, shallower portions of a stream. Approaches should climb a short distance above the high-water line.

Several rows of stepping stones or rocks can be placed upstream from the tread to begin evening out the flow and slowing the water before it enters the ford. Be sure these rows of rocks are not too close to the trail or water flowing over them might scour the tread.

On trails receiving motorized use, rocks or concrete pavers (figure 58) can strengthen the trail tread and stream approaches for a solid crossing.

Well-constructed shallow stream fords are almost maintenance free. Watch for deep spots developing in the crossing. Floods or seasonal runoff can wash away the approaches. Debris can be trapped in the line of stepping stones, altering flow characteristics. Approaches can erode or turn into boggy traps. Maintenance consists of retaining or restoring an even, shallow flow and solid footing. When working in streams, consult the land manager and a fishery biologist to find out what you can and cannot do.

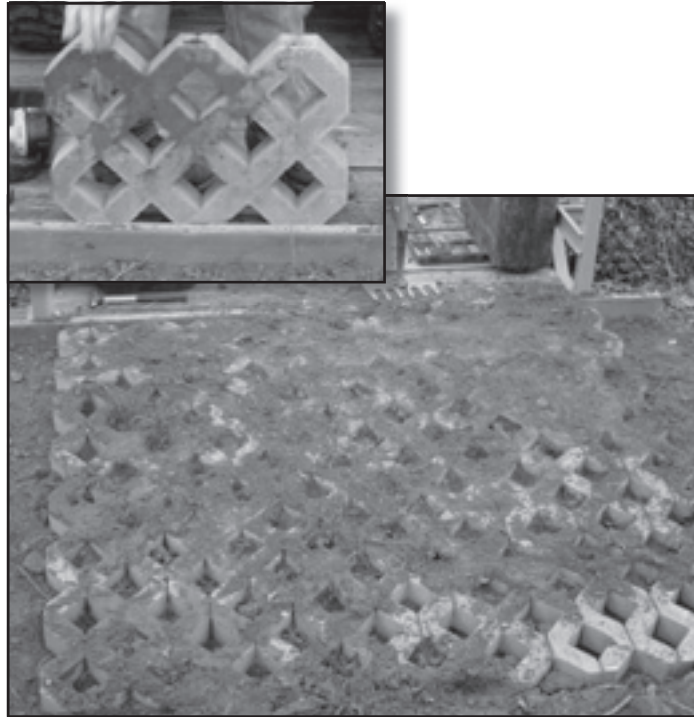

Figure 58—Concrete pavers are good for hardening trails and approaches for motorized use. The voids need to be filled.

Culverts

Culverts are probably the best way to move small volumes of water under a trail (figure 59). The tread extends over the culvert without interruption. Metal or plastic culverts can be installed easily, or culverts can be constructed out of rock.



Figure 59—Culverts are a good option for moving small volumes of water under a trail.

To install metal or plastic culverts, dig a ditch across the trail as wide as the culvert and somewhat deeper. Bed the culvert in native soil shaped to fit it. There needs to be enough drop (about 3 percent) from one side of the trail to the other to keep water flowing through the culvert without dropping sediment. The culvert needs to be covered with 150 millimeters (6 inches) or more of fill. Cut the culvert a little longer than the trail's width, and build a rock facing around each end to shield the culvert from view and prevent it from washing loose. Often a rock-reinforced spillway will reduce headcutting and washouts on the downhill side of the culvert.

The local trail manager may have definite preferences for metal, plastic, wood, or rock culverts. Synthetic materials may be taboo in wilderness. Plastic is lighter than metal, easy to cut, and less noticeable. Aluminum or plastic are preferred over steel in acidic soils. Painting the ends of aluminum or steel culverts helps camouflage them. A culvert should be big enough to handle maximum storm runoff and allow it to be cleaned easily. Usually this means the culvert should be at least 260 millimeters (9 inches) in diameter.

Rock culverts offer workers a chance to display some real trail building skills (figure 60). Begin by laying large, flat stones in a deep trench to form the bottom of the culvert. In some installations, these rocks may not be necessary. Then install large, well-matched stones along either side of the trench. Finally, span the side rocks with large, flat rocks placed tightly together so they can withstand the expected trail use. Cover the top rocks with tread material to hide and protect the culvert. These culverts need to be large enough to clean out easily. The rocks should not wiggle.

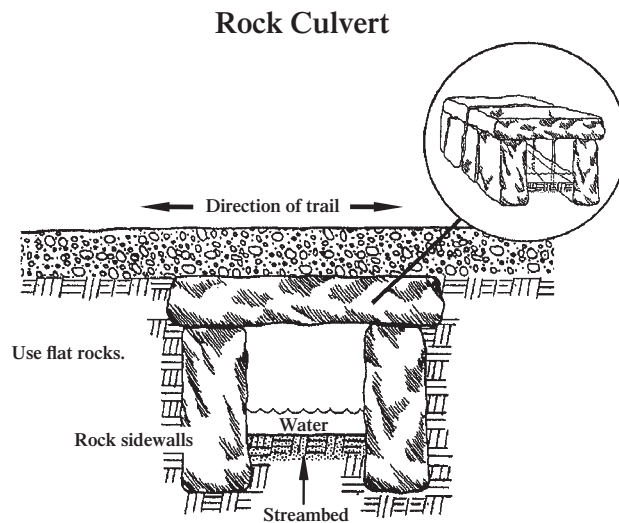

Figure 60—Rock culverts may have stones laid along the culvert’s bottom. The perfect rocks shown here are seldom found in nature.

Water flowing toward a culvert often carries a lot of silt and debris. If the water slows as it goes into the culvert, the silt and debris may settle out, clogging the culvert. A good way to help prevent this problem is by constructing a **settling basin** at the inlet to the culvert (figure 61). This basin should be at least 300 millimeters (1 foot) deeper than the base of the culvert. Sediment will settle out in the basin, where it is much easier to shovel away, rather than inside the culvert.

Rock Culvert

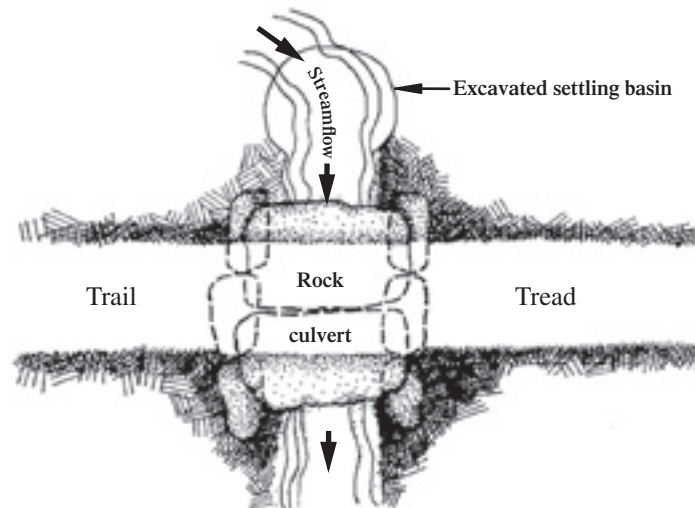

Figure 61—Settling basins help prevent culverts from clogging with silt and debris.

Bridges

Trail bridges range from a simple foot bridge with a handrail (figure 62) to multiple span, suspended, and truss structures. In the Forest Service, handrails are required on all bridges unless an analysis (design warrant) shows that the risk of falling off the bridge is minimal or the trail itself presents a higher risk. All bridges require a curb.

Design Approval

On national forests, all bridges require design approval from engineering before being constructed. Some regions have standardized, approved designs for simple bridges.



Figure 62—A simple footbridge with a handrail.

On hiking trails, log footbridges (figure 63) can be used to cross streams or to provide access during periods of high runoff. Log footbridges consist of a log, sills, and bulkheads. The log needs drainage and airspace to keep it from rotting. The foot log should be level and well anchored. Notch the sill—not the log—when leveling the foot log. The foot log should be no less than 457 millimeters (18 inches) in diameter. The top surface should be hewed to provide a walking surface that is at least 250 millimeters (10 inches) wide. Don't let the log or rails sit on the bare ground. Remove all bark from logs and poles.

If the foot log is associated with a shallow stream ford, be sure to position the log upstream or well downstream of the ford. Logs immediately below the crossing can trap travelers who lose their footing in the ford.



Figure 63—A log footbridge. The sill can be notched to accommodate the logs, but not vice versa. Photo has been digitally altered.

Choosing the materials for a bridge is not a simple process. Even the use of native material for a simple foot log has consequences. For example, most untreated logs of a durable wood (like coastal Douglas-fir) have a useful life of less than 20 years. Yet it may take 100 years

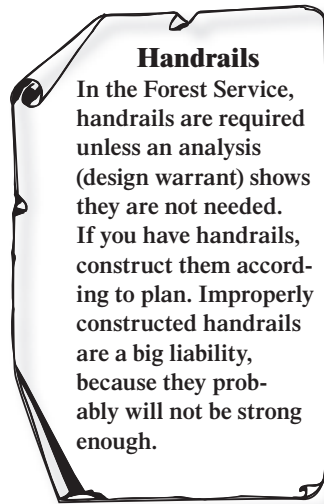

for a log to grow big enough to support visitor traffic and winter snow loads. The typical bridge has three to four stringers. Multiply this replacement-to-growth ratio by several replacement cycles and you can see how it's possible to create a slow-motion clearcut around a bridge site.

Often, materials are imported to avoid the problem of "clearcuts" near the bridge. Pressure-treated wood, metal, concrete, wood laminates, and even fiber-reinforced polymers are being used in bridges. Many of these materials must be trucked or flown to a bridge site and the old materials must be hauled out.

All this is really expensive. Yet the cost of transporting durable materials may be less than the cost of frequently rebuilding structures made with native materials. It's possible to mix-and-match steel or other "unnatural but hidden" components with wood facing and decking to achieve a natural appearance.

Unless your bridge is preassembled and flown right onto a prepared set of abutments, you'll end up moving heavy materials around the bridge site. Be careful not to allow winch guylines and logs to scar trees and disturb the ground. Damage done in a moment can last for decades.

Other types of trail bridges include multiple-span, suspended, and truss structures (figure 64). A two-plank-wide suspended footbridge with cable handrails is more complex than it looks. Midstream piers for multiple span structures need to be designed by qualified engineers to support the design loads and to withstand the expected flood events. It does no one any good to win the National Primitive Skills Award for building a gigantic bridge by hand—only to have it fail a year later because of a design or construction oversight.



Figure 64—A suspension trail bridge typical of the Northern Rockies.

Bridges are expensive, so it makes sense to take good care of them. Check foot logs and bridges annually for problems. Loose decking, planking, curbs, or handrails should be repaired as soon as possible. Clean debris and organic material from all exposed wood surfaces on the bridge or supporting structures. Structural members should be checked for shifting, loose, or missing spikes or bolts. Approaches need to be well drained so water does not run onto the bridge.

Report any of the following problems to a qualified bridge inspector who can determine whether the bridge should remain open to traffic: rotten wood; bent, broken, or disconnected steel members; large checks, splits, crushed areas, or insect damage in wood members; permanent sag or excessive deflection; erosion around abutments; broken concrete; concrete with cracks larger than 3 millimeters ($\frac{1}{8}$ inch); or exposed rebar.

The Forest Service requires all bridge structures to be inspected by a certified bridge inspector at least every 5 years.

A good online resource for more information is MTDC's "Trail Bridge Catalog" (Eriksson 2000).

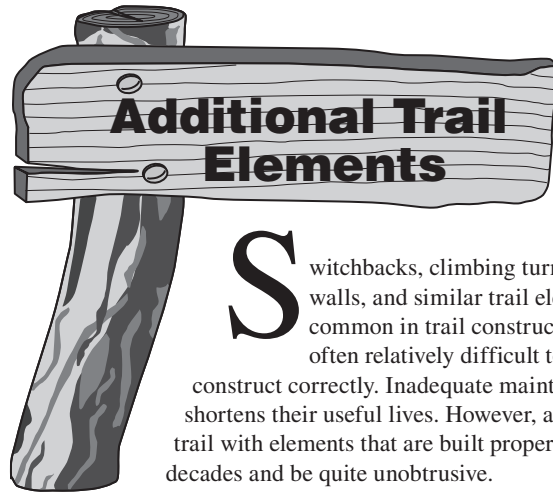

Switchbacks, climbing turns, retaining walls, and similar trail elements are common in trail construction. They are often relatively difficult to design and construct correctly. Inadequate maintenance greatly shortens their useful lives. However, a well-designed trail with elements that are built properly can last for decades and be quite unobtrusive.

The best way to learn how to build trail elements is to seek someone who has a reputation for designing and building well-thought-out switchbacks, climbing turns, or walls. Have that expert conduct a seminar for your crew or actually participate in the construction of a trail you're working on.

Switchbacks and climbing turns are used to reverse the direction of travel on hillsides and to gain elevation quickly (figure 65). What is the difference between the two? A *climbing turn* is a reversal in direction that maintains the existing grade going through the turn without a constructed landing. Climbing turns have a wider turn radius and are used on gentle slopes, typically 15 percent or less. Ideally, 7-percent sideslopes are best.

A *switchback* is also a reversal in direction, but it has a relatively level constructed landing. Switchbacks are used on steeper terrain, usually steeper than 15 percent. Switchback turns have pretty tight corners because of the steeper grades. Usually, special treatments such as approaches, barriers, and drainages need to be considered. Both of these turns take skill to locate. Choosing when to use each one is not always easy.

Switchbacks and Climbing Turns

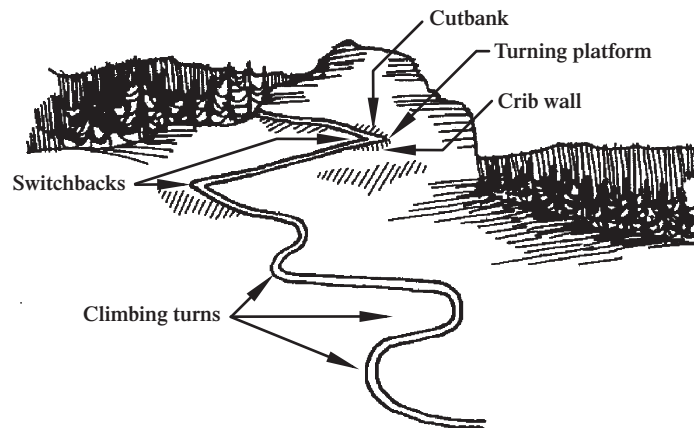

Figure 65—Climbing turns should be built on gentler sideslopes, usually 15 percent or less. Ideally, 7-percent sideslopes are best.

Understanding user psychology (human or animal) is more important to the success of climbing turns and switchbacks than to the success of any other trail element. The turns must be easier, more obvious, and more convenient than the alternatives. Climbing turns work best when terrain or vegetation screens the view of travelers coming down the upper approach toward the turn. Avoid building sets of these turns on open hillsides unless the terrain is very steep. It's usually best not to build turns, or the connecting legs of a series of turns, on or across a ridge. The local critters have trav-

Don't Overdo It

Keep in mind the minimum tool philosophy and build only as many trail elements as you absolutely need to reach your goal.

Plan carefully to avoid impassable or very difficult terrain, reducing the need for switchbacks and climbing turns.

eled directly up and down these ridges since the last ice age. They are not going to understand why you are building low hurdles in their path, and they will not be forced onto your trail and turns.

Climbing Turns

Climbing turns are the trail element most often constructed inappropriately. The usual problem is that a climbing turn is built (or attempted) on steep terrain where a switchback is needed. A climbing turn is built on the slope surface, and where it turns, it climbs at the same rate as the slope itself. Climbing turns work best when built on slopes of 15 percent or less.

The advantages of climbing turns in appropriate terrain is that a wider radius turn of 4 to 6 meters (13 to 20 feet) is relatively easy to construct (figure 66). Trails that serve off-highway-vehicle traffic often use insloped, or banked turns so that riders can keep up enough speed for

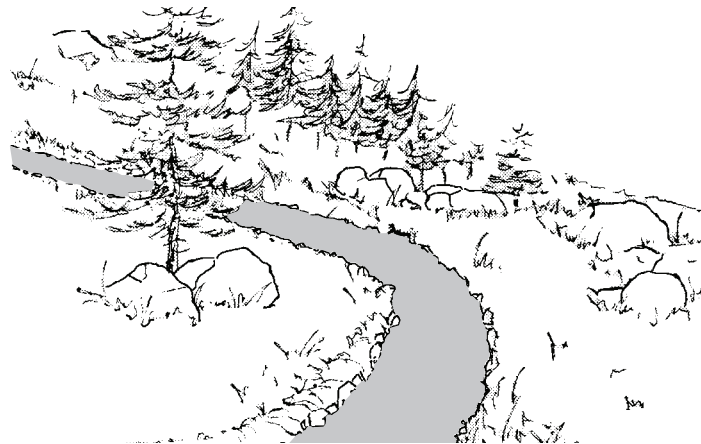

Figure 66—Climbing turns continue the climb through the turn. They can be insloped or outsloped. Add grade reversals at both approaches to keep water off the turn.

control. Climbing turns are also easier than switchbacks for packstock and bikes to negotiate (figure 67). Climbing turns are usually less expensive than switchbacks because much less excavation is required and fill is not used.



Figure 67—Climbing turns are easier for packstock and cyclists to negotiate than switchbacks.

The tread at each end of the turn should be full-bench construction, matching that of the approaches. As the turn reaches the fall line, less material will be excavated. In the turn, the tread should not require excavation other than that needed to reach mineral soil.

To prevent shortcutting, wrap the turn around natural obstacles or place guide structures along the inside edge of the turn. The psychologically perfect place to build climbing turns is through dense brush or dog-hair thickets of trees. Always design grade reversals into both of the approaches to keep water off the turn.

Switchbacks

Switchbacks are used in steep terrain (figure 68). Suitable terrain for a switchback becomes harder to locate and maintenance costs increase as the sideslope becomes steeper. Sideslopes from 15 to 45 percent are preferred locations for switchbacks. Although switchbacks can be constructed on sideslopes of up to 55 percent, retaining structures are needed on such steep slopes.

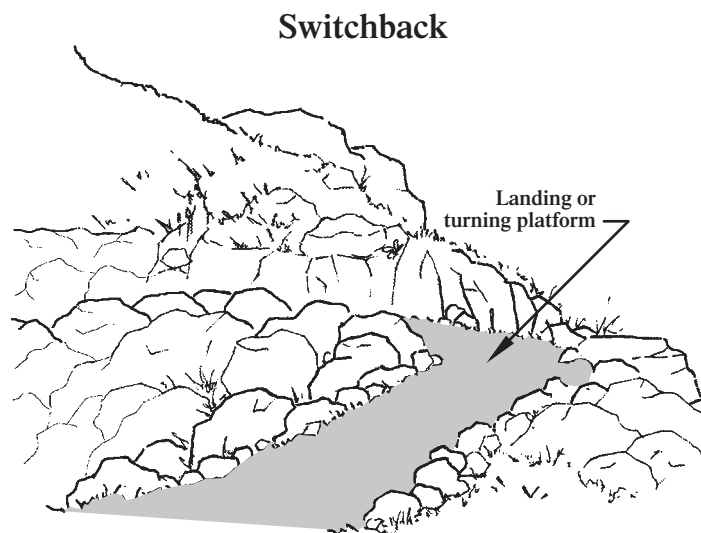

Figure 68—A switchback with a turning platform.

Switchback turns are harder to build correctly than climbing turns, but they keep tread stable on steeper terrain. Most switchbacks are constructed to a much lower standard than is needed. The key to successful switchback construction is adequate excavation, using appropriate structures to hold the fill in place, and building psychologically sound approaches.

Look for natural platforms when you are scouting for possible switchback locations. Use these platforms as control points when locating the connecting tread. Suitable platforms will save you a lot of time later by reducing the amount of excavation and fill needed.

A switchback consists of two approaches, a landing or turning platform, a drain for the upper approach and platform, and guide structures. The upper approach and the upper half of the turning platform are excavated from the slope. Part of the lower approach and the lower half of the turn are constructed on fill (figure 69).



Figure 69—Part of the lower approach and the lower half of this switchback are constructed on fill.

The approaches are the place where most of the trouble starts with switchback turns. The approaches should be designed for the primary user group. In general, the last 20 meters (65 feet) to the turn should be as steep as the desired level of difficulty will allow. This grade should be smoothly eased to match that of the turn in the last 2 to 3 meters (6 ½ to 10 feet).

Do not flatten the grade for 20 meters (65 feet) before the turn. If anything, steepen the approach grades to foster the sense that the switchback is the most convenient way of gaining or losing altitude (figure 70). There is absolutely nothing as infuriating as walking a nearly flat grade to a distant switchback turn while looking several meters over the edge at the nearly flat grade headed the other direction. You can build a Maginot Line of barricades and still not prevent people, packstock, and wildlife from cutting your switchback. The only exception is a trail designed primarily for wheeled vehicles where a flatter approach makes it easier for riders to control their vehicles.



Figure 70—The rocks help prevent users from being tempted to cut this switchback.

As the upper approach nears the turn, a grade reversal should be constructed. The tread below this point should be insloped until the halfway point in the turn. Both sides of this drain ditch should be back-sloped to an angle appropriate for the local soil. As the turn is reached, the tread should be 0.5 to 1 meter (19 to 39 inches) wider than the approach tread. This is particularly important on small radius turns and for wheeled vehicles. It's less necessary for hikers and packstock.

The turn can be a smooth radius ranging from 1.5 to 3 meters (5 to 10 feet) or a simple Y-shaped platform. A smooth radius turn is important if the trail's use includes wheeled traffic or packstrings. The Y platform works for hikers (figure 71). The turn platform is nearly flat, reaching no more than a 5-percent grade. The upper side is excavated from the

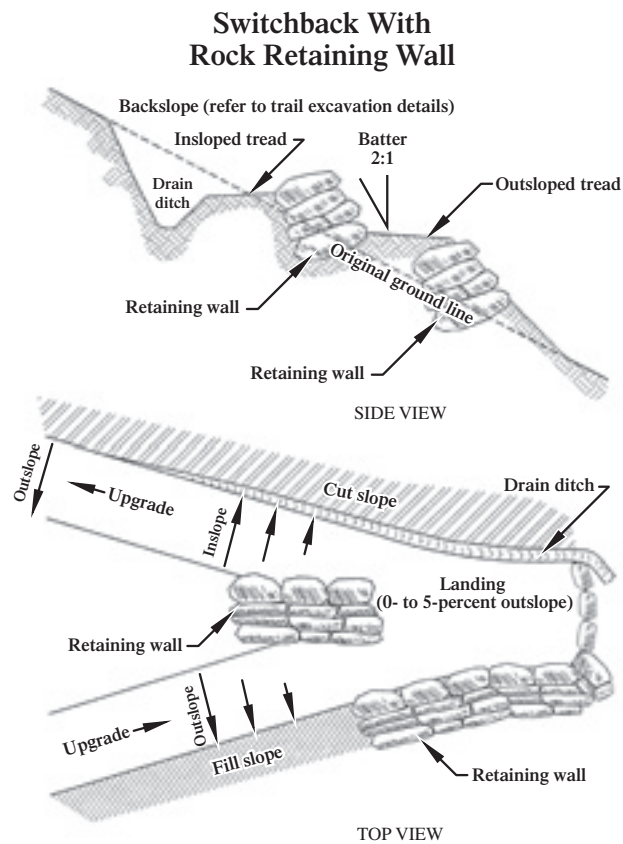

Figure 71—A switchback with a “Y” turning platform, suitable for hiking trails.

sideslope and borrow is used to construct the fill on the lower side. Switchbacks on steep sideslopes can require very large excavations to reach a stable backslope angle and provide clearance for packstock loads. The greater the turn's radius, the wider the platform, or the flatter the turn, the more excavation that will be required. A point may be reached where a retaining wall is needed to stabilize the backslope.

The amount of tamped fill required on the lower side of the turn will usually be at least as much as was excavated from the upper side unless a retaining wall is used to support the fill. A retaining wall is absolutely necessary where the terrain is steeper than the angle of repose for the fill material.

The tread in the upper portion should be insloped, leading to a drain along the toe of the backslope. This drain should extend along the entire backslope and be daylighted (have an outlet) where the excavation ends. Construct a spillway for the drain to protect the adjacent fill from erosion. You may need guide structures—rock walls or logs are common—on the inside of the turn to keep traffic on the trail.

Construct the approach on the lower side of the turn on tamped fill. The retaining wall should extend for most of this length. The tread on the lower portion of the turn should be outsloped. The fill section transitions into the full-bench part of the approach; the approach changes grade to match the general tread grade.

Try to avoid “stacking” a set of switchback turns on a hillside. Long legs between turns help reduce the temptation to shortcut. Staggering the turns so that legs are not the same length reduces the sense of artificiality (figure 72). Keep the grade between turns as steep as the challenge allows. Remember, travelers will cut switchbacks when they feel it's more convenient to do so than to stay on the tread. The designer's goal is to make travel on the trail more attractive than the shortcut.

Maintaining climbing turns and switchbacks requires working on the tread, improving drainage, and doing any necessary work on retaining walls, guide structures, and barricades. The tread should be insloped or outsloped as necessary, slough should be removed to return the tread to design width, and tread obstacles should be removed.

Switchbacks

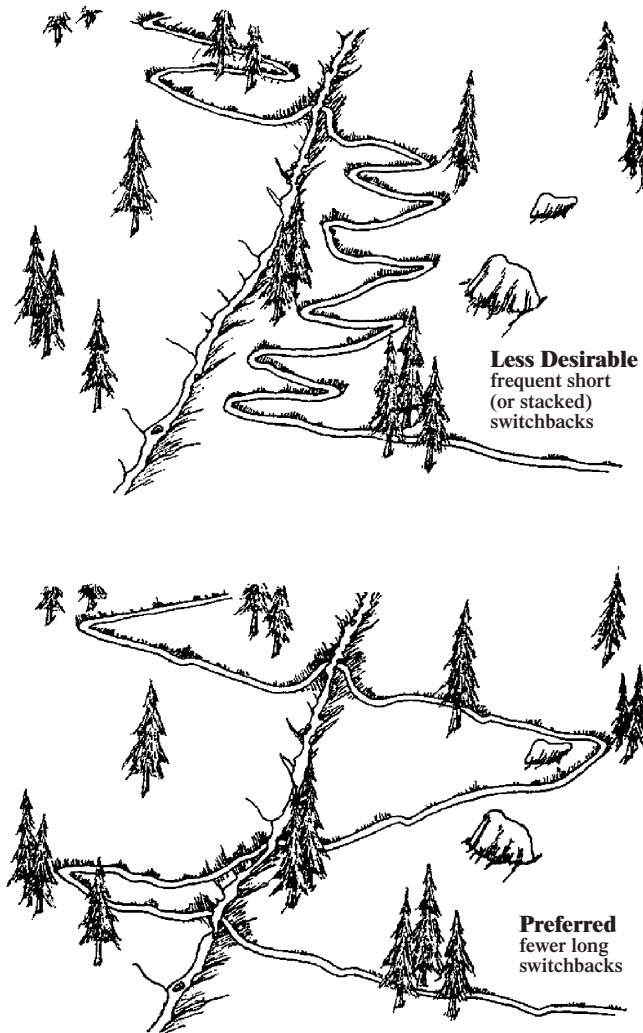

Figure 72—Long sections of trail between switchbacks are usually better than short sections—fewer switchbacks will be needed, with fewer turns to shortcut.

Retaining Walls

Retaining structures keep dirt and rock in place. The retaining wall keeps fill from following the call of gravity and taking the tread with it. Retaining walls are useful for keeping scree slopes from sliding down and obliterating the tread, for keeping streams from eroding abutments, and for holding trail tread in place on steep sideslopes.

Two common retaining structures are the *rock retaining wall* and the *log crib wall*. Of course, rock is more durable and lasts longer than wood.

Rock retaining walls are used when a sturdy wall is needed to contain compacted fill (figure 73) or to hold a steep excavated backslope in place (figure 74). Rock retaining walls are also called *dry masonry* because no mortar is used between the rocks.



Figure 73—A rock retaining wall is needed to hold compacted fill.



Figure 74—A rock retaining wall holding a steep, excavated backslope in place.

Ideally, the bigger the rock, the better. Big rocks are less likely to shift or become dislodged. At least half of the rocks should weigh more than 60 kilograms (130 pounds). The best rock is rectangular with flat surfaces on all sides. Round river rock is the worst.

To build a rock retaining wall, excavate a footing to firm, stable dirt or to solid rock. Tilt the footing slightly into the hillside (*batter*) so the rock wall will lean into the hill and dig it deep enough to support the foundation tier of rocks (these are usually the largest rocks in the wall). Ideally, the footing is dug so that the foundation tier is embedded for the full thickness of the rocks.

The batter should range from 2:1 to 4:1 (figure 75). Factors determining this angle include the size and regularity of the rock, the depth of header rocks, and the steepness and stability of the slope. At batter angles steeper than 4:1 or so, cement, internal anchors, or both, may be needed for stability.

Rock Retaining Wall Terminology

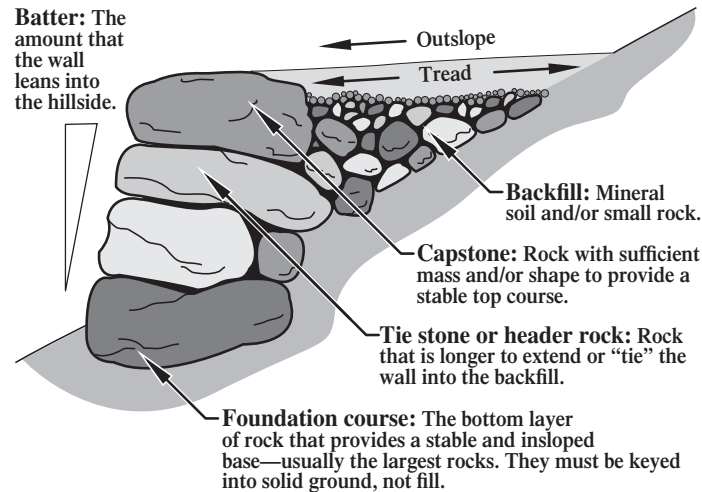

Figure 75—Terms used to describe rock retaining walls.

The *keystone* is laid into the footing and successive tiers are laid. For each tier, overlap the gaps between rocks in the next lower tier, called breaking the joints. Each tier should be staggered slightly into the hill to create the desired amount of batter. *Header rocks* are long rocks turned and placed so that they extend deep into the hillside. Using header rocks is particularly important if the wall’s cross section widens as the wall gets higher.

Rocks in each successive tier should be set so they have at least three points of good contact with the rocks below. Good contact is defined as no wobble or shifting under a load without relying on shims (or chinking) to eliminate rocking. Shims are prone to shifting and should not be used to establish contact, especially on the face of the wall, where they can fall out. Add backfill and tamp crushed rocks into the cracks as you build.

The Right Rock

In reality, you have to use the rock that is available. Small walls can be constructed successfully from small rocks. The key is the foundation and batter. Remember to save some large rocks for the *capstones*. A final point—most rock can be shaped with a few good blows with a rock hammer and carbide-tipped rock chisel. Placing rock on dirt rather than another rock before striking it will help ensure that the rock breaks where you want it to.

Log walls are designed to keep compacted fill in place (figure 76). Construct wood walls by interlocking logs or beams, pinned or notched (for logs) at the joints. Lay sill logs at right angles to the direction of travel and alternate tiers of face logs and header logs (figure 77).

Each successive tier is set to provide enough batter to resist creep pressure from the slope and to reduce pressure on the face logs from the fill. The ends of the header logs are seated against the backslope of the excavation for stability. As fill is tamped in place, filler logs are placed inside the structure to plug the spaces between the face logs. Filler logs are held in place by the fill.



Figure 76—Crib walls help keep compacted fill in place.

Crib Wall

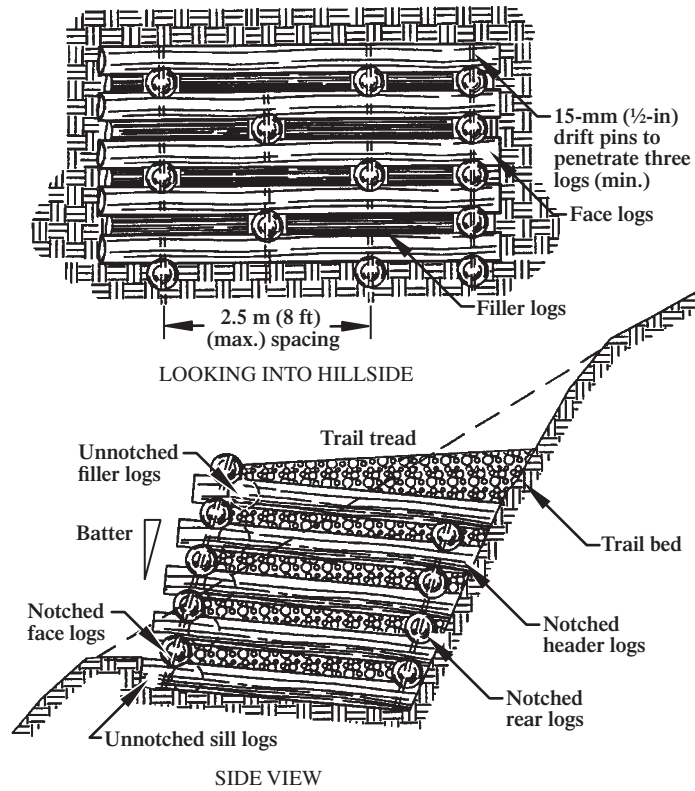

Figure 77—The characteristics of a crib wall. Treated logs are recommended.

Outslope the tread to keep water from saturating the fill and excavation. Use guide structures to keep traffic off the edge of the tread.

All retaining structures should be checked carefully for shifting, bulging, or loose structural material. Make sure that all the footings are protected from erosion. Anchor guides should be secure.

Wire baskets (often called *gabions*) are another retaining structure. Gabions are wire baskets filled with rock (figure 78). The baskets are wired together in tiers and can be effective where no suitable source of well-shaped rock is available. Gabions look more artificial (in the eyes of traditionalists at any rate) and may not last as long as a rock wall, depending on the type of wire used and the climate.



Figure 78—Wire baskets, often called gabions, are another retaining structure.

Steps

Steps are used to gain a lot of elevation in a short distance. Steps are common on steep hiking trails in New England and elsewhere and less common (but not unheard of) on western trails used by horses and mules. Wooden steps of all configurations are common in coastal Alaska (figure 79).



Figure 79—A step-and-run boardwalk in Alaska.

Sometimes steps are used on an existing trail to fix a problem caused by poor trail location or design. Often, the result is out of character with the desired experience and esthetics of the trail. Before you construct steps, make sure they are consistent with the expectations of those the trail is designed to serve.

Your goal is to design the height (rise) and depth (run) of the steps to match the challenge desired. Steps are harder to negotiate as the rise increases. The difficulty also increases as the steps are closer together.

Yet as the trail becomes steeper, the step must either be higher or the distance between steps must be shorter. Steps can be built into a trail that traverses the slope. This allows the traveler to gain elevation rapidly, without the scary steepness of a stairway.

The components of a step are: the rise, the run, a landing on easier grades, and often retainer logs (figure 80). The rise is the height of the face of each step. The run is the distance from the edge of one step to the base of the next step's face. The landing is the extension of the run above the step. In structures where the landing is composed of tamped fill material, logs are used to retain the fill.

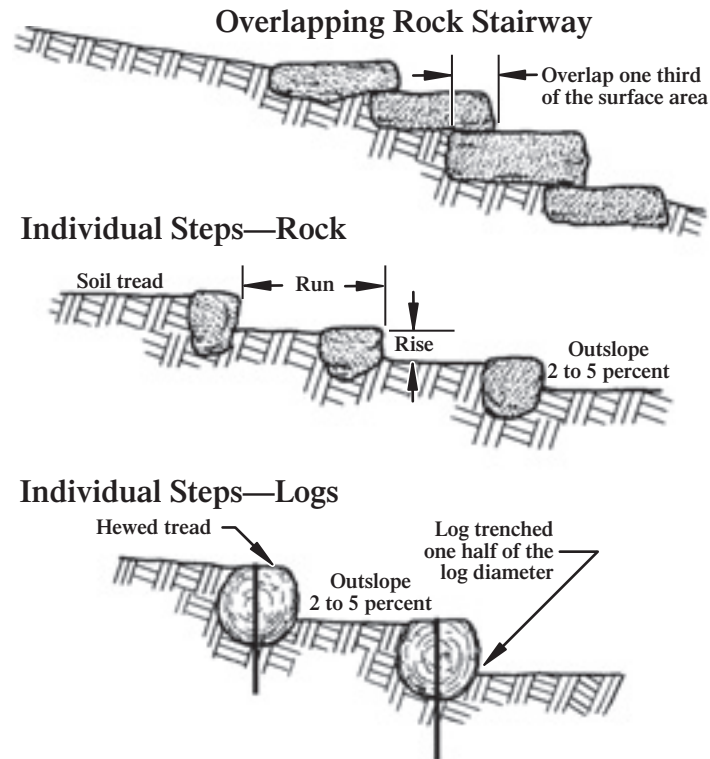

Figure 80—Common types of steps.

Hikers, especially backpackers, generally don't like steps and will walk alongside them if there is any opportunity. The steps need to be comfortable to climb or they won't be used. This means keeping the rise a reasonable 150 to 200 millimeters (6 to 8 inches) and the run long enough to hold a hiker's entire foot, 254 to 305 millimeters (10 to 12 inches, figure 81). It's helpful to corral the sides of steps with rocks to encourage users to stay on the steps.

Stair Proportions

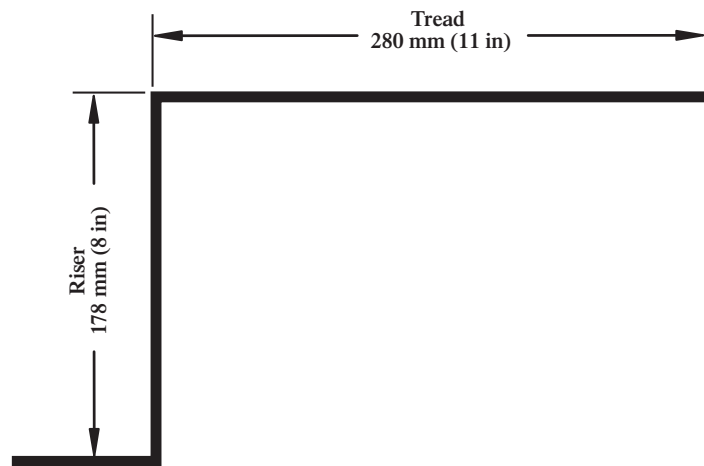

Figure 81—A general rule of thumb for stairs: twice the riser plus the tread should equal 635 to 686 millimeters (25 to 27 inches).

The most important area of the step is usually the tread. This is where most users step as they climb. The top of the step (and landing) should be stable and provide secure footing. The edge of the step should be solid and durable. The face or riser of each step should not slope back too far. This is particularly important as the rise of the step increases.

If the stairway climbs straight up the hill, each step should be slightly crowned to drain water to the edges or be sloped slightly to one side. When the trail traverses a slope, each step and landing should be out-sloped slightly. Water should not be allowed to descend very far down a set of steps or to collect on the landing. A grade reversal or drain dip is a good idea where the trail approaches the top of the steps.

Build stairways from the bottom up, at a break in the grade. Bury the first rock; it will act as an anchor. The most common mistake is to start part way up a grade. If you do so, the trail will wash out below the stairs. The bottom step should be constructed on a solid, excavated footing. If it is constructed on top of exposed rock, it should be well pinned to the footing. Each successive step is placed atop the previous step (figure 82). Wood steps are usually pinned to each other and to the footing. Dry masonry rock steps usually rely on the contact with the step below and with the footing to provide stability (figure 83).

Step Construction

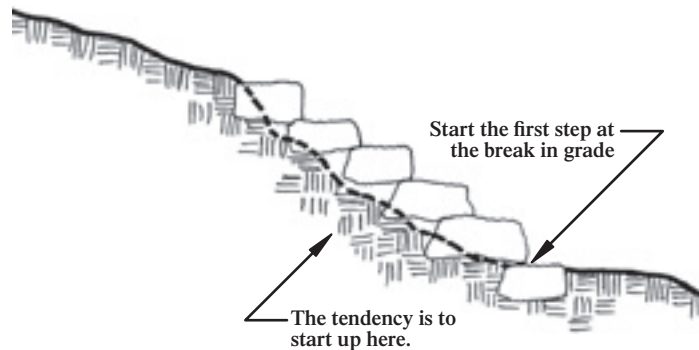

Figure 82—Begin laying steps at the bottom of a grade rather than midway.



Figure 83—Each dry masonry rock step needs to contact the step below.

Steps with landings are a bit harder to secure because the steps do not overlap. Each step can be placed in an excavated footing and the material below the rise removed to form the landing of the next lower step. Usually, this is the most stable arrangement. Or the step can be secured

on the surface and fill can be used to form a landing behind it. When the landing consists of tamped fill, the material used to provide the rise does double duty as a retaining structure. These steps must be seated well to prevent them from being dislodged by traffic. For stock use, landings should be long enough, about 2 meters (6 ½ feet), to hold all four of the animal's feet (figure 84).



Figure 84—For stock use, landings should be long enough to hold all four of the animal's feet, or about 2 meters (6 ½ feet) long.

In all steps, the key is to use the largest material possible and to seat it as deeply as possible. Rocks should be massive and rectangular. On steps that traverse a slope, it helps to seat the upper end of the step in footings excavated into the slope.

Pavers

Pavers can be used to armor switchback turns and steeper slopes, especially on trails designed for motorized traffic (figure 85). Some styles of pavers allow vegetation to penetrate them; others have voids that can be filled with soil, gravel, or other suitable material. In highly erodible soils, pavers combined with geotextiles are an option.



Figure 85—Pavers can be used to armor sections of trail for motorized traffic.



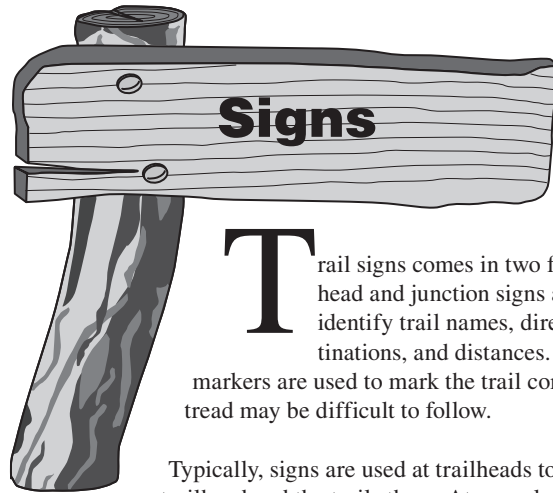

Trail signs come in two forms. Trailhead and junction signs are used to identify trail names, directions, destinations, and distances. Reassurance markers are used to mark the trail corridor when the tread may be difficult to follow.

Typically, signs are used at trailheads to identify the trailhead and the trails there. At some locations, destinations accessed by these trails and the distances to the destinations will be displayed. Signs also are used at system trail junctions (and road crossings) to identify each trail by name and indicate its direction. Signs may identify features, destinations, and occasionally, regulations, warnings, or closures.

Reassurance markers include cut blazes on trees; wood, plastic, or metal tags; posts; and cairns. Reassurance markers are more useful as the tread becomes more difficult to identify and follow. These markers help travelers identify the trail corridor when the tread is indistinct, the ground is covered with snow, or when the route is confused by multiple trails or obscured by weather, such as dense fog. National trails usually are marked periodically with specially designed tags.

The number of signs or reassurance markers depends primarily on the planned user skill level. Low-challenge trails typically will be signed with destinations and distances. Usually, the trail will be so obvious that reassurance marking is necessary only at points where users might be confused. As the desired opportunity for challenge rises, the amount of information given by signs usually drops to trail identification and direction. You may find special guidelines for wilderness areas.

Installing Signs

Trail signs are made of a variety of materials; the most typical is Car-sonite or wood. Usually, signs are mounted on posts or trees. Signs in rocky areas should be mounted on a post seated in an excavated hole or supported by a well-constructed cairn.

Wooden posts may be obtained onsite or hauled in. Onsite (native) material is usually less expensive, but may have a shorter useful life. Native material looks less artificial; it may be preferred in primitive settings. Purchased posts should be pressure treated. Their longer lifespan will offset the higher initial purchase and transportation costs. Round posts appear less artificial than square posts and provide more options for custom alignment of signs at trail junctions. Posts should be at least 150 millimeters (6 inches) in diameter.

Signs should be placed where they are easy to read, but far enough from the tread to leave clearance for normal traffic. Different agencies have special rules regarding signs. Make sure you're following the rules that apply to your trail. In deep snow country, try to locate the post in relatively flat surroundings to reduce the effects of snow creep, which can carry signs down the hill.

Sign Plans

The number and types of signs and reassurance markers should be detailed in a sign plan for the area you are working in. Consistent with the plan, signs and markers should be esthetically appropriate, visible, in useful locations, and well maintained. Install no more signs than necessary.

Spikes or lag screws can be used at the base of the post to improve anchoring (figure 86). Seat the post in the hole and keep it vertical while you drop a few rocks into the hole to secure it. Tamp these rocks with a rockbar or tool handle to jam them into place. Continue to place rocks and dirt in the hole, tamping as you go. Top off the hole with mounded soil to accommodate settling and to prevent water from puddling around the post.

Signpost Installation

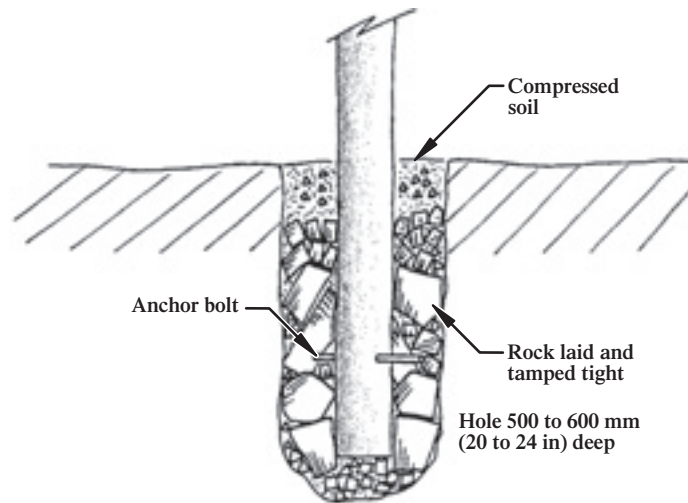

Figure 86—The key to placing solid posts is to tamp the rock and soil with a rockbar as you fill the hole.

In rocky areas or very soft soils (such as those next to a turnpike), signposts can be supported by a cairn. Horizontally placed spikes or lag screws should be used at the base for anchors. Chinking the cairn with smaller rocks helps tighten the post against the larger stones. “Anchoring Trail Markers and Signs in Rocky Areas” (Watson 2005) provides instructions for installing signposts without using heavy tools and equipment.

Signs should have holes already drilled so they can be attached to the post. Level each sign and secure it with galvanized lag screws or, better yet, through-bolts that have a bolt head and washer on one side and a washer and nut on the other. Galvanized hardware reduces rust stains on the sign. New wood preservatives like ACQ (alkaline copper quaternary compound) are highly corrosive to aluminum and carbon steel. Use triple-dipped galvanized fasteners. Galvanized washers should

be used between the head of the screw and the sign face to reduce the potential for the sign to pull over the screw. In areas where sign theft is a problem, use special theft-prevention hardware.

The bottom edge of signs should be set about 1.5 meters (60 inches) above the tread. The sign's top edge should be 50 millimeters (2 inches) below the top of the post. Where snow loads are a problem, the post can be notched and the signs seated full depth in the post. Treated posts will be susceptible to rotting where they are notched, so they should be spot treated with preservative.

Use caution when mounting signs to trees. The sign should be obvious to travelers and legible from the tread. If signs mounted on trees doesn't meet these conditions, use a post instead. Mount signs to trees with galvanized lag screws and washers, rather than spikes. That way, the sign can be loosened periodically to accommodate tree growth. Leave a gap between the sign and the tree to allow for the growth.

Installing Reassurance Markers

Reassurance markers are used only where the trail is not obvious. If the tread is obvious during the regular use season, these markers aren't needed. Reassurance markers may be helpful if a trail is hard to follow because the tread is indistinct, regularly covered with snow during part of the normal use season, or if weather conditions (such as fog) make the trail hard to distinguish at times. Reassurance markers also are helpful at junctions with nonsystem (informal) trails, or where multiple trails cause confusion.

Place reassurance markers carefully. They should be clearly visible from any point where the trail could be lost. This is a judgment call, often controversial, based on the challenge level served by the trail and the conditions along it. Higher challenge trails need fewer markers; lower challenge trails may need more.

Each marker location should be flagged before installation and checked for visibility in the desired direction of travel. Each location should be marked in both directions (on both sides of the same tree) so there is no question whether or not the marker is official. The marking decisions should be based on traffic traveling in both directions. Be conservative with markers. It's better to improve tread visibility than to rely on markers, except on high-challenge trails where tread frequently may not be visible at all.

The classic reassurance marker is a blaze cut on a tree. The standard Forest Service *blaze* should always be used to differentiate it from the freeform blazes and antler rubbings that appear on nonsystem trails (figure 87). Cut blazes carefully because a mistake can't be repaired. If a blaze is consistently buried by snow during part of the use season, the

Blazes and Marker Tags

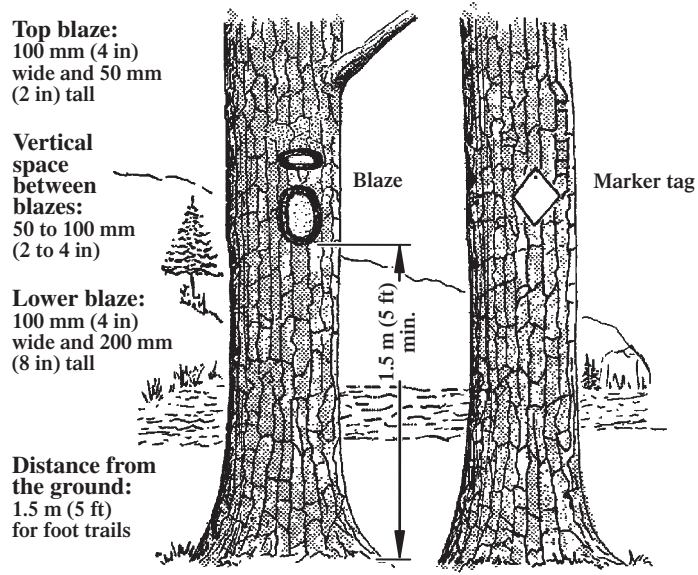

Figure 87—Blaze trees on both sides. Cut the blaze no deeper than needed for clear visibility. Blazes are no longer cut into trees in many parts of the country.

blaze can be cut higher on the tree, but not so high that it becomes difficult to locate from the tread. Cut blazes may, on rare occasions, need to be freshened—recut them carefully.

Blazes are no longer cut on trees in many parts of the country. Check with your local trail manager to learn what's appropriate. Policies vary across the Nation.

Different types of blazes may be used on some specially designated trails, such as the Appalachian Trail. **Blazers** (sometimes called marker tags) are used when higher visibility is desired and esthetic considerations are not critical. The most common tags are colored diamonds of plastic or metal, reflective for night use or nonreflective when called for in the trail management plan. Various colors are used. These tags should be mounted on trees using aluminum nails. Allow 12 millimeters ($\frac{1}{2}$ inch) or so behind the tag for additional tree growth. Directional arrows, where appropriate, should be placed in a similar fashion. Markers also can be mounted on wooden or fiberglass posts.

Blazers should be checked for continued usefulness. If the tread is more obvious than when these markers were originally installed, consider removing some. If folks are getting lost, restore more visible tread, move existing blazers to more visible locations, or add a few more where they will be most effective. Remove all signs and blazers that don't fit the plan for the area.

Painted blazes are sometimes used. Be absolutely sure to use a template of a size and color specified in your trail management plan. Don't let just anyone start painting blazes.

Cairns are used in open areas where low visibility or snow cover makes it difficult to follow the tread or where the tread is rocky and indistinct. Two or three stones piled one on top of the other—sometimes called rock ducks—are no substitute for cairns and should be scattered at every opportunity. Cairns are similar in construction to rock cribs and consist of circular tiers of stones (figure 88).

Cairns

Use flat stones and overlap the joints.

Slope stones inward.

Do not use small stones wedged in cracks for structural support.

Use large stones to build the base.

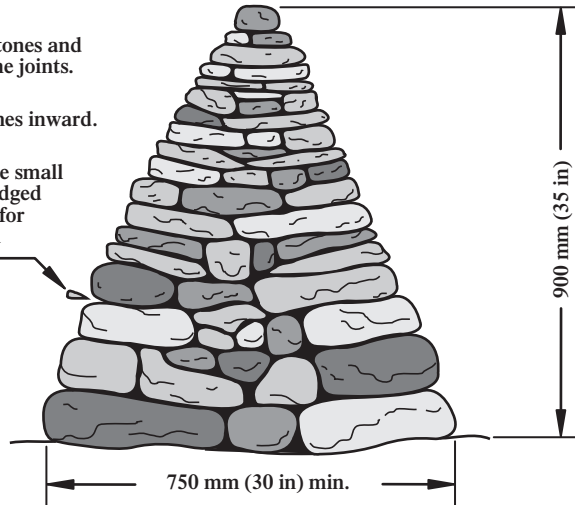

SIDE VIEW

Overlap all joints.

Pack the center with rubble.

Illustrations courtesy of the Appalachian Mountain Club's Trail Adopter Handbook.

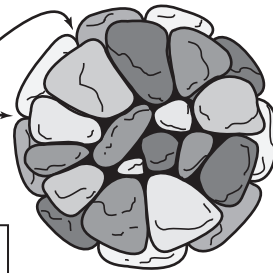

TOP VIEW

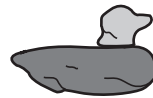

Rock Duck

Figure 88—Two- or three-stone rock ducks are no substitute for cairns and should not be built.

Make the base of the cairn wide enough to provide enough batter for stability. In really deep snow country, you may need to add a long guide pole in the center as the cairn is built. If it's appropriate to remove the guide pole during the summer, a pipe can be built into the center of the cairn, allowing the guide pole to be removed easily.

Cairns should be spaced closely enough that the next cairn is visible in either direction from any given cairn during periods of poor visibility (such as dense fog). Cairns should be placed on small rises (not in swales). If cairns are used in areas of large talus, use a 2-meter (6.5-foot) guide pole in the center to distinguish the cairn from other piles of rock. The best time to decide where to place cairns is during a day with poor visibility.

In some settings, *guide poles* are more effective than cairns. They are most useful in snowfield crossings to keep traffic in the vicinity of the buried trail. Guide poles should be long enough to extend about 2 m (6.5 ft) above the top of the snowpack during the typical season of use. Guide poles should be at least 100 mm (4 in) in diameter. They should be sturdy enough to withstand early season storms before the snow can support them and to withstand pressures from snow creep later in the season. Avoid placing guide poles in avalanche paths. Don't mark trails for winter travel if they cross known avalanche paths.

Guide poles are also used in large meadows where tall grasses make cairns hard to spot, or where there is too little stone for cairns.

Maintaining Signs and Markers

Sign maintenance consists of remounting loose or fallen signs, repairing or replacing signs, and resetting or replacing leaning, damaged, rotting, or missing posts.

If the sign is missing, a replacement sign should be ordered and installed. Consider why the sign is missing. If the sign was stolen, consider using theft-resistant hardware to mount its replacement. If



Photo Sign Inventories

Before-and-after photos help document what is happening to signs in the field and how new signs look before the forces of nature (and visitors) resume work. A good sign inventory with photos makes it easier to order replacements for missing or completely trashed signs.

the sign was eaten by wildlife, consider less palatable materials. If weather or natural events munched the sign, consider stronger materials, a different location, or a different system for mounting the signs.

For signs mounted on trees, you may need to loosen the lag screws slightly to give the tree growing room. If the sign is on a post, check to make sure that it is snugly attached. Replace rotting posts. Don't just try to get through "one more season."

Check with your manager for guidelines that will help you decide when signs should

be replaced because they have bullet holes, chipped paint, missing or illegible letters, incorrect information, cracked boards, splintered mounting holes, or missing pieces. Consider the consequences of not repairing or replacing deficient signs. Take some photos to help portray the situation.





Reclaiming abandoned trails requires as much attention and planning as constructing a new trail. If you're rerouting a section of trail, the new section needs to be well designed, fun, and better than the one you're closing. If your new trail doesn't provide a better experience than the old trail, visitors will keep using the old one!

The goal is to reduce the impact trails have on the landscape. Simple restoration may consist of blocking shortcuts and allowing the vegetation to recover. Complex restoration projects include obliterating the tread, recontouring, and planting native species. Careful monitoring and followup are needed to ensure that almost all evidence of the old trail is gone. Restoration projects range from simple and relatively inexpensive to complex and costly (figure 89).



Figure 89—A candidate trail for a turnpike or rerouting, followed by reclamation of the old trail.

For more detailed advice on restoration, see the “Wilderness and Backcountry Site Restoration Guide” (Therrell and others 2006).

Past practices of trail abandonment have left permanent scars on the land. You probably know of abandoned trails that had a few logs and rocks dragged into the tread and trenches. Decades later, those same trails are still visible, still eroding, still ugly, and sometimes, still being used!

Reclamation strategies include: closure, stabilization, recontouring, revegetation, and monitoring. Restoration needs to be carefully planned. The consequences of each strategy should be examined. Consult with a hydrologist, landscape architect, and soil and plant specialists when planning to reclaim an old trail.

Each abandoned trail section should be reclaimed. This is true whether an entire trail is abandoned or a segment with multiple trails is being narrowed to one tread. If the abandoned trail is not blocked to prevent further use, it may persist indefinitely. Closure is particularly important if stabilization and revegetation are to succeed. The abandoned tread should be blocked to all traffic, recontoured, and disguised (figure 90)



Figure 90—Sagebrush is being transplanted to help disguise this reclaimed trail.

to prevent users from being tempted to take it. This work should be completed for all segments visible from trails that remain open.

Stabilizing abandoned tread to prevent further erosion will promote natural revegetation in some instances. Trails break natural drainage patterns and collect and concentrate surface waterflows. Restoring the natural contour of the slope reestablishes the local drainage patterns and reduces the likelihood of erosion. Recontouring usually eliminates any temptation to use the old trail and assists revegetation. Pull fillslope material back into the cut and use additional material to rebuild the slope, if necessary.

Completely break up or scarify the compacted tread at least 4 inches deep. Doing so will allow native grasses, plants, and seed to take hold and grow. Fill in the visual or vertical opening of the corridor by planting shrubs, trees, and even deadfall (figure 91). Finally, sprinkle leaves and needles to complete the disguise.

Remove culverts and replace them with ditches.



Figure 91—Abandoned trails need to be blocked off effectively, and with sensitivity. Plant native grasses and plants. Use shrubs or deadfall to fill the opening left by the abandoned trail.

Check Dams

Check dams are used on sections of abandoned, trenched tread to stop erosion and hold material in place during site restoration. Check dams are intended to slow and hold surface water long enough for the water to deposit sediment it is carrying. Check dams should be used with drainage structures to reduce overall erosion from the abandoned tread (figure 92).

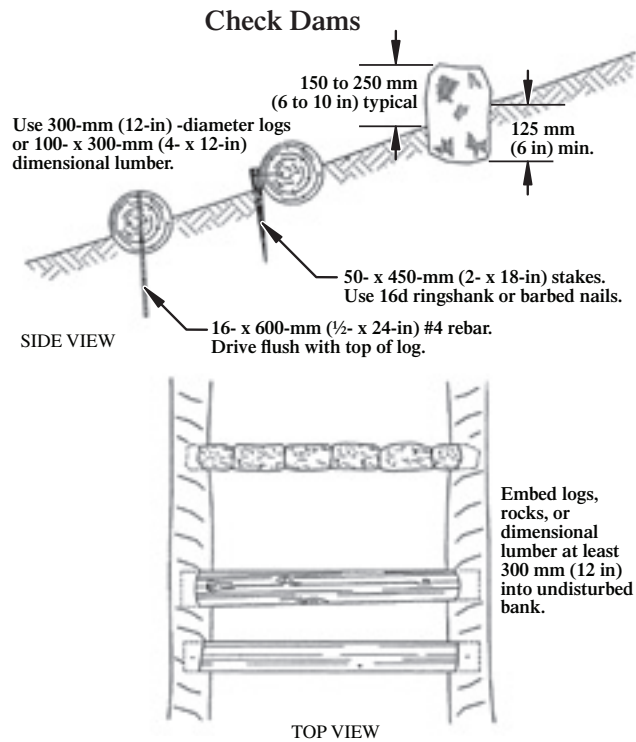

Figure 92—Check dams allow soil to rebuild on eroded trails.

Check dams are best used as holding structures for fill to help recontour the old tread. The material used in the dam should be seated in an excavated footing that extends into the sides of the gully. As material behind

the dam builds up, additional levels can be added to the dam with enough batter to keep the dam stable against the pressure of the fill. The top of the dam should be level or slightly higher than the excavated footing. For watertightness, the uphill face of the dam should be chinked and covered with tamped fill. These trenches take a long time to fill up. Most never do. If they do, add fill below the dam to finish the process.

Spacing between dams depends on the steepness of the old grade and the degree of restoration desired. If the check dams are intended only to slow down erosion on a 25-percent grade, relatively wide spacing is sufficient, every 20 meters (65 feet). If the intent is to fill in half of the old trench, the bottom of each dam should be level with the top of the next lower dam. On steeper grades, the dams need to be closer together (figure 93). If the intent is to approach complete recontouring of the



Figure 93—Over the years, this gully should fill in.

trench, the dams should be closer still, especially on grades steeper than 25 percent. A point of diminishing returns is reached on grades steeper than 40 percent. Check dams would have to be built right on top of each other to retain soil at the full depth of the trench.

Revegetation

Revegetation can be accomplished passively or actively. Passive revegetation allows surrounding vegetation to colonize the abandoned trail. This process works when erosion has been stopped, precipitation is adequate, the tread has been scarified, and adjacent vegetation spreads and grows rapidly. Disturbed soil provides an opportunity for invasive plants to take hold. Active revegetation ranges from transplanting propagated native plants to importing genetically appropriate seed. Successful revegetation almost never happens in a single season. Plan carefully for best results.

There are no cookbook answers for returning abandoned trails to their natural condition. Each site should be evaluated for its potential to regrow and heal. On sites that are moist and relatively flat, it may be possible to block off the trail and allow rehabilitation to proceed naturally. Dry, steep sites will take a lot of work.



Specialized trail tools can help make your trail work more enjoyable.

Remember:

- Your most important tool is your brain—use it.
- Always use proper personal protective equipment, such as hardhats, gloves, and safety glasses. Make sure a job hazard analysis has been approved and a safety plan is being followed.
- Select the right tool for the job. Carefully inspect each tool. Make sure the handles are sound, smooth, and straight, and that the heads are tight.
- Pace yourself. Take rest breaks, drink plenty of water, and keep your mind on your work. Crewmembers should trade off on work tasks occasionally for relief from repetitive stresses.
- Keep cutting tools sharp. A dull tool makes your work harder and more dangerous.
- Before you start, clear away any brush or limbs that might catch a swinging tool.
- Posture is important. Stand comfortably in balance. Adjust your stance and tool grip continually to prevent slipping and to avoid glancing blows. Be especially careful when working in wet, slippery conditions.
- Be thinking about the consequences of every move. If you are working with a rock or log, think ahead so you are not standing in the wrong place when it moves. Be ready to toss your tool aside and jump free. Avoid cutting toward any part of your body, and watch out for your coworkers. Use skill, not brute force.

- When carrying, loading, or storing a cutting tool, cover the blade with a sheath to protect both the sharp edge and yourself. In vehicles, make sure tools are fastened down.
- Maintain at least 3 meters (10 feet) between workers as a safe operating distance when using individual chopping and cutting tools.
- Carry sharp tools at your downhill side. Grasp the handle at about the balance point with the sharpened blade forward and down. If you fall, throw the tool clear.
- At the work site, lay tools on the uphill side of the trail with the business end farthest uphill. Make sure the handles are far enough off the edge of the trail so they are not a tripping hazard. Never sink double-bit axes, McLeods, Pulaskis, mattocks, or similar tools into tree trunks, stumps, or the ground where the exposed portion of the tool will present a hazard.

Tools for Measuring

Clinometers—A clinometer, called a clino by trail workers, is a simple, yet useful, instrument for measuring grades. Most clinometers have two scales, one indicating percent of slope, the other showing degrees. Percent slope, the relationship between rise or drop over a horizontal distance, is the most commonly used measure. Percent readings are found on the right hand side of the scale. Don't confuse percent and degree readings. It is easy to do! Expressed as an equation:

$$\text{Percent of Grade} = \frac{\text{Rise}}{\text{Run}} \times 100 \text{ percent}$$

A section of trail 30 meters (100 feet) long with 3 meters (10 feet) of difference in elevation would be a 10-percent grade. A 100-percent grade represents 45 degrees.

Traditionalists often prefer an Abney level to a clinometer. They are easier to see through and there are no measurements to read.

Global Positioning Systems (GPS)—Most trail surveyors are using GPS receivers for accurate trail location, inventory, and contract preparation. Real-time correction is no longer necessary and prices have fallen. GPS is becoming the norm for locating trails.

Tape Measures—Get a tape measure with metric units. Mark off commonly used measurements on your tool handles. Know the length of your feet, arms, fingers, and other rulers that are always handy on the trail. Calibrate the length of your pace over a known course so you can easily estimate longer distances.

Tools for Sawing

Bow Saws—These saws are useful for clearing small downfall and for limbing. They consist of a tubular steel frame that accepts replaceable blades. The blades can be removed by loosening a wing nut or releasing a throw clamp.

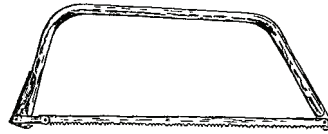

Bow saw

Chain Saws—A chain saw can make short work of your cutting tasks—but it is not for wilderness use. Specialized instruction and certification are required, so make sure you are certified before operating a chain saw.

Crosscut Saws—Symmetric crosscut saws, those designed for a sawyer at either end, follow two basic patterns. Felling crosscuts are light, flexible, and have concave backs that conform easily to the arc of the cut and the sawyer's arm. The narrowed distance between the teeth and back

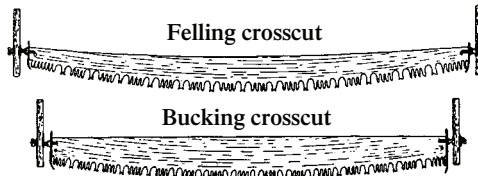

leaves room for sawyers to get wedges into the cut quickly. Bucking crosscuts have straight backs and are heavier and stiffer than felling saws. Bucking saws are recommended for most trail work because they are more versatile.

Bucking saws also are available as asymmetric saws, with a handle at one end that can be used by a single sawyer.

Cover the blades with sections of rubber-lined firehose slit lengthwise. Velcro fasteners make these guards easy to put on and take off. When carrying a saw, lay it flat across one shoulder with a guard covering the teeth. The teeth need to face away from the neck. Don't leave a wet guard on a saw.

A sharp crosscut saw is a pleasure to operate, but a dull or incorrectly filed saw is a source of endless frustration, leading to its reputation as a misery whip. Never sharpen a saw without a saw vise and the knowledge to use it. Field sharpening ruins crosscut saws.

Warren Miller's classic, the "Crosscut Saw Manual" (revised 2003), provides information on sharpening techniques. David E. Michael's "Saws That Sing: A Guide To Using Crosscut Saws" (2004) tells you everything else you will need to know. Both are available from the Federal Highway Administration's Recreational Trails Web site: <http://www.fhwa.dot.gov/environment/fspubs/>.

A saw's teeth are needle sharp. Wear gloves when sawing and keep your hands clear of the cut and the blade. Carry bow saws by your side with the blade pointed down. Cover the blade with plastic blade guards or small-diameter fire hose secured with Velcro fasteners. Always carry spare parts and plenty of replacement blades.

Pruning Saws—Pruning saws are useful for limbing, some brushing, and removing small downfall, especially where space is limited and cutting is difficult. Folding pruning saws are handy.



Folding pruning saw

Tools for Chopping

Axes—Axes are of two basic types: single or double bit. Double-bit axes have two symmetrically opposed cutting edges. One edge is maintained at razor sharpness. The other edge usually is somewhat duller, because it is used when chopping around rocks or dirt. Mark the duller edge with a spot of paint.

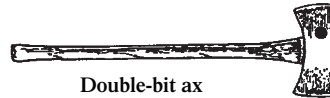

Double-bit ax



Single-bit ax

Before chopping with an ax, check for adequate clearance for your swing. Remove any underbrush and overhanging branches that might interfere. Be sure your footing is stable and secure. Chop only when you are clear of other workers.

Stand comfortably with your weight evenly distributed and both feet planted shoulder-width apart. Measure where to stand by holding the handle near the end and stretching your arms out toward the cut. You should be able to touch the blade to the cut.

Begin chopping by sliding your forward hand within 150 millimeters (6 inches) of the axhead. As you swing, your forward hand slides back down the handle to the other hand. Just after impact, give the handle a slight twist to pop severed wood out of the cut.

Proficiency with axes requires practice. Inexperienced users and dull axes can cause serious accidents. In general, the force of the swing is not as important as accurate placement. Always chop away from your body. Stand where a glancing blow will not strike you. If you must cut toward yourself, “choke up” on the handle with both hands and use short swings for more control.

“An Ax to Grind—A Practical Ax Manual” (Weisgerber and Vachowski 1999) is a good reference.

Tools for Grubbing

Combination Tools—

The combination or combi tool is basically a military entrenching tool on a long handle, developed for firefighting. It serves as a light-duty shovel and scraper.



Combi tool

Fire Rakes (Council Tools)—The fire rake is another fire tool widely used for trail work, especially in the East.

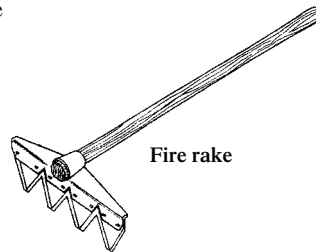

Fire rake

Hoes—Use an adze hoe, grub hoe, or hazel hoe to break up sod clumps when constructing new trail or when leveling an existing trail tread. These hoes also are useful in heavy duff. They generally work better than a Pulaski.

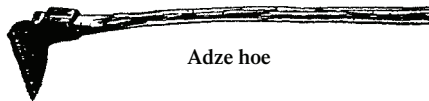

Adze hoe

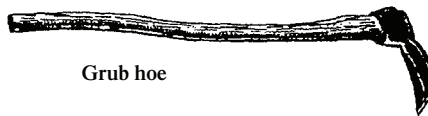

Grub hoe

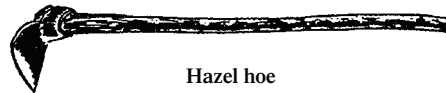

Hazel hoe

Mattocks—The pick mattock is often recommended as the standard tool for trail work. For many applications, it is much better than a Pulaski. It has a pointed tip for breaking rocks and a grubbing blade for working softer materials. The grubbing blade also may be used to cut roots or remove small stumps. With the edge of the tool, you can tamp dirt and loose rocks or smooth a new tread.



Pick mattock



Cutter mattock

A pick mattock can be used to pry rocks without fear of breaking a handle. Two people working with pick mattocks may not need to carry rock bars.

Maintain good cutting edges on mattocks. Sharpen grubbing blades to maintain a 35-degree edge bevel on the underside. Sharpen pick ends as you would a pick, and maintain factory bevels on cutter blades.

McLeods—The McLeod combines a heavy-duty rake with a large, sturdy hoe. McLeods work well for constructing trails



McLeod tool

through light soils and vegetation or for reestablishing tread when material from the backslope sloughs onto the trail. A McLeod is essential for compacting tread and is helpful for checking outslope. If you hate leaving a bolt impression in your compacted tread, remove the bolt that secures the toolhead and weld the head to the mounting plate. McLeods are inefficient in rocky or unusually brushy areas.

Picks—Pick heads have a pointed tip that can break up hard rock by forcing a natural seam. They also have a chisel tip for breaking softer materials.

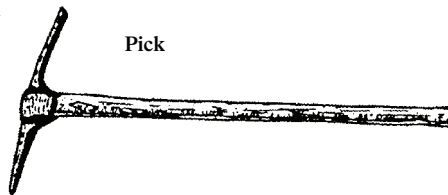

Pick

Work the pick as you would the hoe on a Pulaski with short, deliberate, downward strokes. Avoid raising the pick overhead while swinging. Always wear safety goggles while using a pick to protect yourself from flying rock chips.

Use a grinder or mill bastard file to sharpen the pointed tip to a 3-millimeter ($\frac{1}{8}$ -inch) square. When sharpening the chisel tip, maintain the factory bevel.

Pulaskis—The Pulaski combines an ax and a grub hoe into a multipurpose firefighting tool. It isn't as good as a hoe or mattock for grubbing, nor is it as good as an ax for chopping. It is a popular trail tool, mostly because it is widely available and easier to carry than several single-purpose tools.

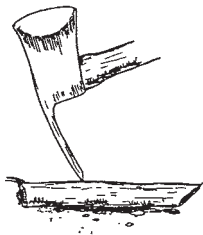

When using the hoe end of a Pulaski, stand bent at the waist with your back straight and parallel to the ground, knees flexed, and one foot slightly forward. Hold the handle with both hands so the head is at an angle to your body, and use short, smooth, shallow swings. Let the hoe hit the ground on its corner. Use the ax end to chop large roots after the dirt has been cleared by the hoe. Always wear safety goggles while grubbing to protect yourself from flying chips of rock and dirt.

Carry the Pulaski at your side. Grip the handle firmly near the head and point the ax end away from your body and down.

Sharpen the cutting edge of the Pulaski's ax as you would any other ax. When sharpening the Pulaski's hoe end, maintain the existing inside edge bevel. Never sharpen the top of the hoe.

Stump Grinders—If you have lots of stumps to remove, consider buying or renting a gasoline-powered stump grinder. These portable grinders are powered by a chain saw motor and have carbide teeth that can be sharpened or replaced. They grind through a stump in much less time and with a whole lot less frustration than would be needed to dig the stump out.



Stump grinder

Tools for Digging and Tamping

Digging and Tamping Bars—A digging and tamping bar is about the same length as a rockbar, but much lighter. It is designed with a chisel tip for loosening dirt or rocks and a flattened end for tamping. These bars are not prying tools.

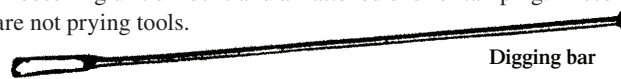

Shovels—Shovels are available in various blade shapes and handle lengths. The *common*, or *round-point*, shovel weighs between 2.3 and 2.7 kilograms (5 and 6 pounds). Its head measures about 200 by 300 millimeters (8 by 12 inches). If a shovel feels too heavy or large, choose a

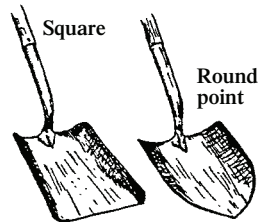

smaller version—remember, you have to lift everything the head holds. The *square* shovel is a flat-bottomed model intended for shoveling loose materials, not digging.

When scooping materials, bend your knees and lift with your legs, not your back. Push the shovel against your thigh, which serves as a fulcrum. This makes the handle an efficient lever and saves your energy and your back. Don't use the shovel to pry objects out of the trail—that's a job for a pick and a pry bar.

Tools for Brushing

Bank Blades and Brush Hooks—Bank blades and brush hooks are designed specifically for cutting through thickets of heavy brush or saplings. Use them for clearing work that is too heavy for a scythe and not suited for an ax.

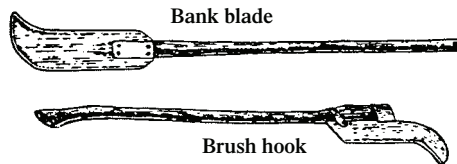

Lopping Shears and Pruning Shears

—Lopping and pruning shears are similar in design and use. Lopping shears have long handles and may have gears to increase leverage for thicker stems. Pruning shears are small enough to fit in one hand and are designed to cut small stems and branches. Cutting edges vary, but generally one blade binds and cuts a stem against an anvil or beveled hook. We recommend the hook and blade shear for overhead cuts because the curved blades

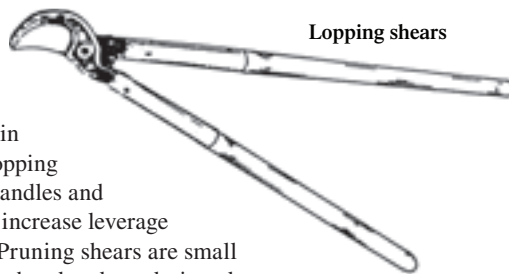

transfer the weight of the shears to the limb. Lopping and pruning shears do a better job of making a nice clean cut than hand saws or axes.

Power Weed Cutters—Several manufacturers make “weed whackers,” motorized weed cutters that use plastic line to cut weeds. Some have metal blades that substitute for the line. These can be a good option for mowing grass and weeds on trails. Follow the manufacturer’s instructions for safe use and operation. Eye protection is especially important.

Swedish Brush (Sandvik)

Axes—These clearing tools work well in brushy thickets or in rocky or confined areas.



Weed Cutters (Grass Whips)—Weed cutters are used for cutting light growth like grasses and annual plants that grow along trails. They are lightweight and durable and usually are swung like a golf club.

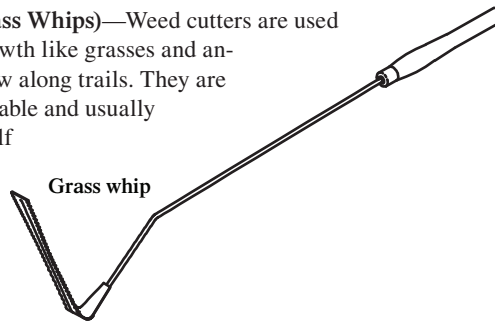

Tools for Pounding and Hammering

Hand-Drilling Hammers—Hand-drilling hammers are used to drill steel into rock or to drive wedges and feathers into cracks or drilled holes. There are two types of hand-drilling hammers—single jacks and double jacks. For more infor-



mation on hand drilling, read “Hand Drilling and Breaking Rock For Wilderness Trail Maintenance” (Mrkich and Oltman 1984).

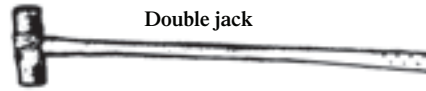

Double jack

Sledge Hammers—Sledge hammers have heads forged from heat-treated high carbon steel; they weigh from 3.6 to 9 kilograms (8 to 20 pounds).

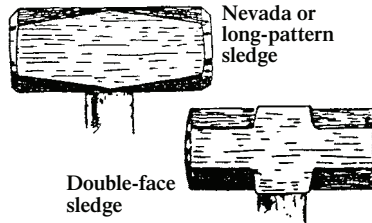

Nevada or long-pattern sledge

Double-face sledge

Driving sledges are used to set heavy timbers and drive heavy spikes or hardened nails. Stone sledges are used to break boulders or concrete. Because of differences in tempering, these tools are not interchangeable.



Stone sledge

Tools for Lifting and Hauling

Block and Tackle—A block and tackle is a set of pulley blocks and ropes used for hoisting or hauling. They come in different styles, sizes, and capacities.

Canvas Bags—Heavy-duty canvas bags sold to carry coal are great for dirt, small rocks, and mulch. They are more durable than similar-looking shopping bags.



Canvas coal bag

Motorized Carriers—If your budget and regulations allow, consider a motorized carrier. They come in various configurations and typically feature a dump body. A trailer pulled behind an all-terrain vehicle may be an alternative to a motorized carrier.



Motorized carrier



ATV trailer

Packstock Bags and Panniers—Fabric bags or hard-sided panniers with drop bottoms work well when packstock are used to carry trail construction materials. A design available for fabric bags is included in “Gravel Bags for Packstock” (Vachowski 1995).



Packstock bag

Rockbars—Use a rockbar (also called pry bar) for lifting or skidding large, heavy objects. These bars are heavy duty. They have a chisel tip on one end. The other end can be rounded or pointed.



Rockbar

Place the tip of the chisel under the object to be moved. Wedge a log or rock between the bar and the ground to act as a fulcrum. Press the handle down with your weight over your palms. Never straddle the bar when prying. When the object raises as much as the bite allows, block it and use a larger fulcrum or shorter bite on the same fulcrum to raise the object farther.

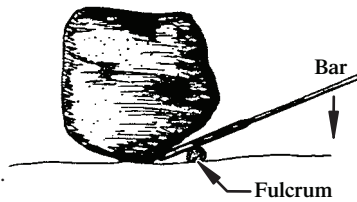

The rounded end of a rockbar is great for compacting material into rock cracks when armoring trail. You can use the pointed end to break large rocks by jabbing the point into a crack and twisting.

Tools for Peeling and Shaping

Bark Spuds (Peeling Spuds)—Use a bark spud to peel green logs. Have the log about hip high. Hold the tool firmly with both hands and push the dished blade lengthwise along the log under the bark. Always peel away from your body. Its three sharpened edges make this tool unusually hazardous to use and transport.



Bark spud

Drawknives—A drawknife works best to peel dry logs. Position the log about waist high, and grasp both handles so the beveled edge of the blade faces the log. Begin each stroke with arms extended and pull the tool toward you while keeping even pressure on the blade. Keep your fingers clear of the blade's corners.

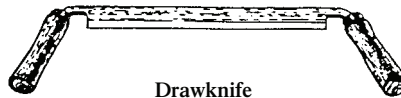

Drawknife

Tools for Sharpening

Inspect all tools before use. Sharpening makes tools last longer. A small scratch that is ignored could lead to a serious crack or nick in the blade.

Use a file or grindstone to remove metal from a dull edge. If there are no visible nicks, a touchup with a whetstone will restore a keen cutting edge. In these instances, you need only restore the edge bevel. Whet-

ting the edge removes very small bits of metal from the blade and causes the remaining metal to burr slightly on the cutting edge. This burr is called a feather,

or wire edge. Remove this weak strip by honing the edge on the other side. The correctly honed edge is sharp, does not have a wire edge, and does not reflect light or show a sharpening line. Wear gloves when sharpening cutting edges.

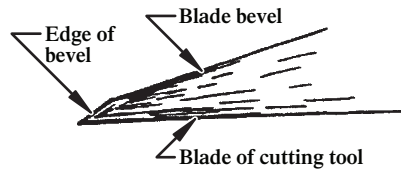

Blade Bevels

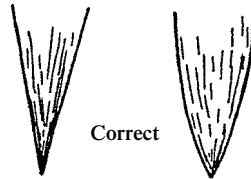

Correct



Wrong

Restoring the blade bevel requires coarser grinding tools to reshape worn cutting blades. Reshape blades with hand files, sandstone wheels, or electric grinders. Remove visible nicks by grinding the metal back on the blade. Remember that the correct blade bevel must be maintained. If the shape can't be maintained, have a blacksmith recondition the toolhead or discard it.

A hand-tool sharpening gauge that gives you all the correct angles can be ordered from the General Services Administration (NSC No. 5210-01-324-2776).

If a cutting edge is nicked by a rock, it may be work hardened. A file will skip over these spots and create an uneven edge. Use a whetstone or the edge of a bastard file to reduce the work-hardened area, then resume filing. Alternate using a whetstone and the file until the file cuts smoothly over the entire length of the edge.

Files—Files come in single or double, curved or rasp cuts. Single-cut files have one series of parallel teeth angled 60 to 80 degrees from the edge; they are used for finishing work. Double-cut files have two series of parallel teeth set at a 45-degree angle to each other; they are used

for restoring shape. Curved files are used for shaping soft metals. Rasp-cut files are used for wood.

Files are measured from the point to the heel, excluding the tang (the tip used to attach a handle). File coarseness is termed bastard, second cut, or smooth. The bastard will be the coarsest file available for files of the same length. A 254-millimeter (10-inch) mill bastard file is good for all-around tool sharpening. Before filing, fit the file with a handle and knuckle guard. Always wear gloves on both hands. Secure the tool so both hands are free for filing. Use the largest file you can. Remember that files are designed to cut in one direction only. Apply even pressure on the push stroke, then lift the file up and off the tool while returning for another pass.

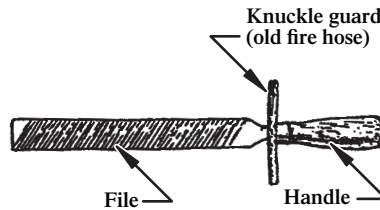

Store or transport files so they are not thrown together. Protect them from other tools as well. An old piece of fire hose sewn shut on one end makes a great holder for several files, a guard, and a handle.

Mechanized Trail Building Equipment

Grading Equipment—Several types of graders that can be pulled with ATVs work well for maintaining wider trails used by motorized traffic. MTDC has designed a rock rake to fit on an ATV for trail work.

An experienced operator can use small mechanized equipment to make wonderful singletrack trails. Such equipment also is great for constructing wider trails for motorized traffic and packstock.

A Web site showing a variety of small mechanized equipment and attachments for trail work can be found at: <http://www.fhwa.dot.gov/environment/equip/>.

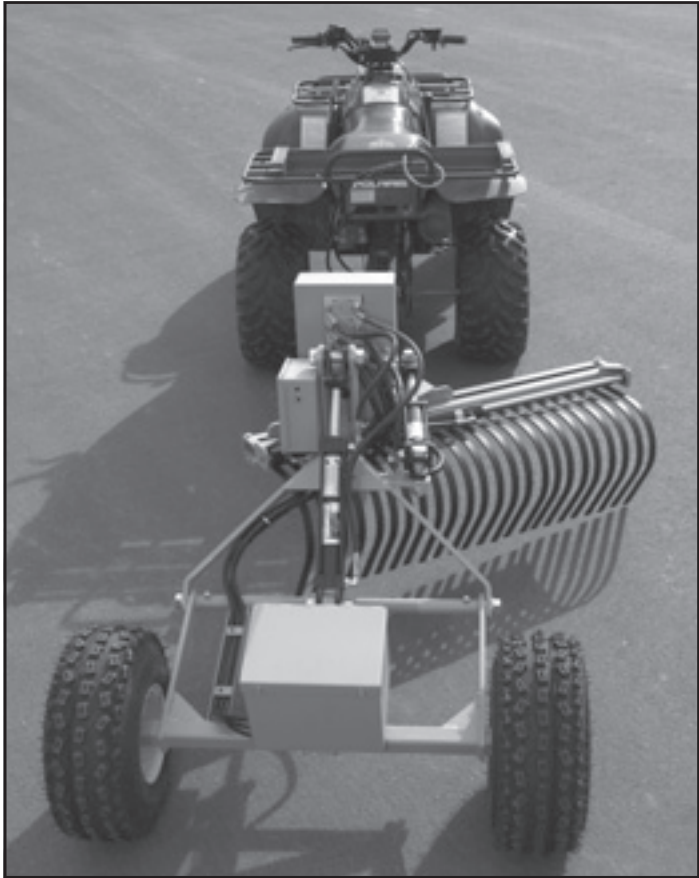

Rock rake designed by MTDC

Mini Excavators—Mini excavators can excavate tread and move material and rocks from place to place. They are even more popular with trail contractors than dozers, because dozers can only push material. Excavators can dig and move material. Mini excavators are available from many manufacturers.



Mini excavator

Trail Dozers—Trail-sized dozers are becoming more common for cutting singletrack trail. When an experienced operator follows a good design, the trails built by a dozer are impressive.



Sweco 480

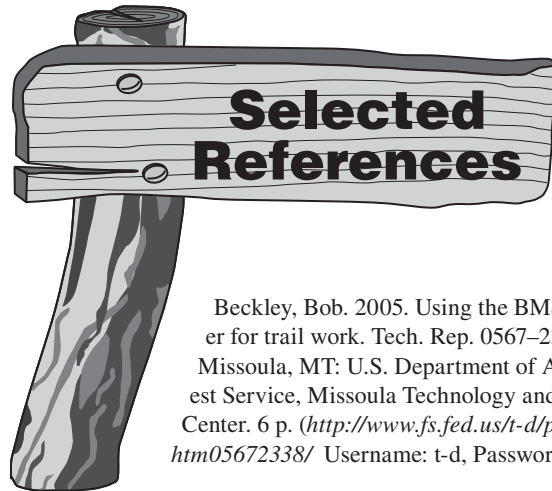

Beckley, Bob. 2005. Using the BMS Micro-Blast-er for trail work. Tech. Rep. 0567-2338-MTDC. Missoula, MT: U.S. Department of Agriculture Forest Service, Missoula Technology and Development Center. 6 p. (<http://www.fs.fed.us/t-d/pubs/htmlpubs/htm05672338/> Username: t-d, Password: t-d)

Birchard, William, Jr.; Proudman, Robert D. 2000. Appalachian Trail design, construction, and maintenance. 2d ed. Harpers Ferry, WV: Appalachian Trail Conference. ISBN 1-917953-72-X. 237 p. (Copies for sale by calling 888-287-8673.)

Birkby, Robert C. 2005. Lightly on the land: the SCA manual of backcountry work skills. 2d ed. Student Conservation Association and The Mountaineers. ISBN 0-89886-4848-3. 304 p. (Copies for sale by calling 206-223-6303, ext 135.)

Davies, Mary Ann; Outka-Perkins, Lisa. 2006. Building mountain bike trails: sustainable singletrack. DVD. 0623-2D01-MTDC. Missoula, MT: U.S. Department of Agriculture Forest Service, Missoula Technology and Development Center. (Order the DVD from the Federal Highway Administration, <http://www.fhwa.dot.gov/environment/rectrails/trailpub.htm>)

Demrow, Carl; Salisbury, David. 1998. The complete guide to trail building and maintenance. 3d ed. Boston, MA: Appalachian Mountain Club. ISBN 1-878239-54-6. 256 p. (Copies for sale by calling 800-262-4455.)

Didier, Steve; Herzberg, Diane. 1996. Stock-drawn equipment for trail work. Tech. Rep. 9623–2802–MTDC. Missoula, MT: U.S. Department of Agriculture Forest Service, Missoula Technology and Development Center. 22 p. (<http://www.fhwa.dot.gov/environment/fspubs/96232802/>)

Eriksson, Merv. 2000. Trail bridge catalog. Web site. 0023–2W01–MTDC. Missoula, MT: U.S. Department of Agriculture Forest Service, Missoula Technology and Development Center. (<http://www.fs.fed.us/t-d/bridges/> Username: t-d, Password: t-d)

Groenier, James Scott; Eriksson, Merv; Kosmalski, Sharon. 2006. A guide to fiber-reinforced polymer trail bridges. Tech. Rep. 0623–2824–MTDC. Missoula, MT: U.S. Department of Agriculture Forest Service, Missoula Technology and Development Center. 98 p. (<http://www.fs.fed.us/t-d/pubs/htmlpubs/htm06232824/> Username: t-d, Password: t-d)

Groenier, James Scott; LeBow, Stan. 2006. Preservative-treated wood and alternative products in the Forest Service. Tech. Rep. 0677–2809–MTDC. Missoula, MT: U.S. Department of Agriculture Forest Service, Missoula Technology and Development Center. 44 p. (<http://www.fs.fed.us/t-d/pubs/htmlpubs/htm06772809/> Username: t-d, Password: t-d)

Hallman, Richard. 1988 (rev. 2005). Handtools for trail work. Tech. Rep. 8823–2601–MTDC. Missoula, MT: U.S. Department of Agriculture Forest Service, Missoula Technology and Development Center. 54 p. (<http://www.fhwa.dot.gov/environment/fspubs/05232810/>)

International Mountain Bicycling Association. 2004. Trail solutions: IMBA's guide to building sweet singletrack. ISBN: 0–9755023–0–1. Boulder, CO: International Mountain Bicycling Association. 272 p.

Kilroy, Bill; Tour, Jim. 1998. Boulder buster: breaking rocks without explosives. 9867–2840–MTDC. Missoula, MT: U.S. Department of Agriculture Forest Service, Missoula Technology and Development Center. (<http://www.fhwa.dot.gov/environment/fspubs/98672840/>)

Kuhn, Tyler; Vachowski, Brian. 2006. Improved MTDC trail rake for ATVs. Tech. Rep. 0623–2320–MTDC. Missoula, MT: U.S. Department of Agriculture Forest Service, Missoula Technology and Development Center. 6 p. (<http://www.fhwa.dot.gov/environment/fspubs/06232320/>)

Meyer, Kevin G. 2002. Managing degraded off-highway vehicle trails in wet, unstable, and sensitive environments. Tech. Rep. 0223–2821–MTDC. Missoula, MT: U.S. Department of Agriculture Forest Service, Missoula Technology and Development Center. 48 p. (<http://www.fhwa.dot.gov/environment/fspubs/02232821/>)

Michael, David; Vachowski, Brian. 2004. Saws that sing: a guide to using crosscut saws. Tech. Rep. 0423–2822–MTDC. Missoula, MT: U.S. Department of Agriculture Forest Service, Missoula Technology and Development Center. 64 p. (<http://www.fhwa.dot.gov/environment/fspubs/04232822/>)

Miller, Warren. 1977 (rev. 2003). Crosscut saw manual. Tech. Rep. 7771–2508–MTDC. Missoula, MT: U.S. Department of Agriculture Forest Service, Missoula Technology and Development Center. 28 p. (<http://www.fhwa.dot.gov/environment/fspubs/77712508/>)

Monlux, Steve; Vachowski, Brian. 2000. Geosynthetics for trails in wet areas: 2000 edition. Tech. Rep. 0023–2838–MTDC. Missoula, MT: U.S. Department of Agriculture Forest Service, Missoula Technology and Development Center. 18 p. (<http://www.fhwa.dot.gov/environment/fspubs/00232838/>)

Mrkich, Dale; Oltman, J. 1984. Hand drilling and breaking rock for wilderness trail maintenance. Tech. Rep. 8423–2602–MTDC. Missoula, MT: U.S. Department of Agriculture Forest Service, Missoula Technology and Development Center. 26 p. (<http://www.fhwa.dot.gov/environment/fspubs/84232602/>)

Parker, Troy Scott. 2004. Natural surface trails by design: physical and human design essentials of sustainable, enjoyable trails. ISBN: 0-9755872-0. Natureshape LLC. (<http://www.natureshape.com>)

Steinholtz, Robert T.; Vachowski, Brian. 2007. Wetland trail design and construction. Tech. Rep. 0723–2804–MTDC. Missoula, MT: U.S. Department of Agriculture Forest Service, Missoula Technology and Development Center. 90 p. (<http://www.fhwa.dot.gov/environment/fspubs/07232804>)

Therrell, Lisa; Cole, David; Claassen, Vic; Davies, Mary Ann. 2006. Wilderness and backcountry site restoration guide. Tech. Rep. 0623–2815–MTDC. Missoula, MT: U.S. Department of Agriculture Forest Service, Missoula Technology and Development Center. 394 p. (<http://www.fs.fed.us/t-d/pubs/htmlpubs/htm06232815> Username: t-d, Password: t-d)

U.S. Department of Agriculture Forest Service. 1999. Health and safety code handbook. FSH 6709.11. Washington, DC: U.S. Department of Agriculture Forest Service. 514 p. (<http://www.fs.fed.us/im/directives/fsh/6709.11/FSH6709.pdf>)

U.S. Department of Agriculture Forest Service. Forest Service trail reports 2004. CD with 28 reports in HTML and PDF formats. 0423–2C03–MTDC. Missoula, MT: U.S. Department of Agriculture Forest Service, Missoula Technology and Development Center. (<http://www.fhwa.dot.gov/environment/rectrails/trailpub.htm/>)

U.S. Department of Agriculture Forest Service. 1991. Trails management handbook. FSH 2309.18. Washington, DC: U.S. Department of Agriculture Forest Service. (http://www.fs.fed.us/cgi-bin/Directives/get_dirs/fsh?2309.18)

U.S. Department of Agriculture Forest Service. 1996. Forest Service National trail drawings and specifications. EM–7720–103. Washington, DC: U.S. Department of Agriculture Forest Service. (<http://www.fs.fed.us/ftp/root/pub/acad/dev/trails/trails.htm>)

U.S. Department of Agriculture Forest Service. 2005. Signs and poster guidelines for the Forest Service. EM–7100–15. Washington, DC: U.S. Department of Agriculture Forest Service. (Reference copies available at Forest Service offices Nationwide.)

Vachowski, Brian. 1995. Gravel bags for packstock. Tech. Rep. 9523–2840–MTDC. Missoula, MT: U.S. Department of Agriculture Forest Service, Missoula Technology and Development Center. 9 p. (<http://www.fhwa.dot.gov/environment/fspubs/95232840/>)

Vachowski, Brian; Maier, Neal. 1998. Off-highway vehicle trail and road grading equipment. Tech. Rep. 9823–2837–MTDC. Missoula, MT: U.S. Department of Agriculture Forest Service, Missoula Technology and Development Center. 20 p. (<http://www.fhwa.dot.gov/environment/fspubs/98232837/>)

Watson, L'Tanga. 2005. Anchoring trail markers and signs in rocky areas. Tech. Rep. 0523–1202–SDTDC. San Dimas, CA: U.S. Department of Agriculture Forest Service, San Dimas Technology and Development Center. 13 p. (<http://www.fs.fed.us/eng/pubs/pdf/05231202.pdf>)

Weisgerber, Bernie; Vachowski, Brian. 1999. An ax to grind: a practical ax manual. Tech. Rep. 9923–2823–MTDC. Missoula, MT: U.S. Department of Agriculture Forest Service, Missoula Technology and Development Center. 60 p. (<http://www.fhwa.dot.gov/environment/fspubs/99232823/>)

Wernex, Joe. 1994. Off-highway motorcycle & ATV trails guidelines for design, construction, maintenance and user satisfaction. 2d ed. Pickerington, OH: American Motorcyclist Association. 58 p. (<http://www.ama-cycle.org/legisltn/downloads/WernexReport.pdf>)

Zeller, Janet; Doyle, Ruth; Snodgrass, Kathleen. 2006. Accessibility guidebook for outdoor recreation and trails. Tech. Rep. 0623–2801–MTDC. Missoula, MT: U.S. Department of Agriculture Forest Service, Missoula Technology and Development Center. (<http://www.fs.fed.us/recreation/programs/accessibility/htmlpubs/htm06232801/>)

Library Card

Hesselbarth, Woody; Vachowski, Brian; Davies, Mary Ann. 2007. Trail construction and maintenance notebook: 2007 edition. Tech. Rep. 0723-2806-MTDC. Missoula, MT: U.S. Department of Agriculture Forest Service, Missoula Technology and Development Center. 166 p.

This notebook describes techniques used to construct and maintain trails. It is written for trail crew workers and is intended to be taken along on work projects. Numerous illustrations help explain the main points. The notebook was printed in 1996 and has been revised slightly during three reprintings. This edition has rearranged and consolidated information throughout the guidebook. Trail construction techniques and references have been updated.

Keywords: climbing turns, drainage, fords, grade reversals, puncheon, reclamation, signs, switchbacks, trail construction, trail crews, trail maintenance, training, turnpikes

Produced by:

USDA Forest Service, Missoula Technology and Development Center
5785 Hwy. 10 West
Missoula, MT 59808-9361
Phone: 406-329-3978
Fax: 406-329-3719

You can order a copy of this document using the order form on the FHWA's Recreational Trails Program Web site at: <http://www.fhwa.dot.gov/environment/rectrails/trailpub.htm>

For additional information about trail construction and maintenance, contact Mary Ann Davies at MTDC:

Phone: 406-329-3981
Fax: 406-329-3719
E-mail: mdavies@fs.fed.us

Electronic copies of MTDC's documents are available on the Internet at:

<http://www.fs.fed.us/eng/t-d.php>

Forest Service and Bureau of Land Management employees can search a more complete collection of MTDC's documents, videos, and CDs on their internal computer networks at:

<http://fsweb.mtdc.wo.fs.fed.us/search/>

Inside Back Cover

Metric Conversions

To convert from this unit	To this unit	Multiply by
inch	millimeter	25.4*
inch	centimeter	2.54*
foot	meter	0.3048*
yard	meter	0.9144*
mile	kilometer	1.6
millimeter	inch	0.039
centimeter	inch	0.394
centimeter	foot	0.0328
meter	foot	3.28
meter	yard	1.09
kilometer	mile	0.62
acre	hectare (square hectometer)	0.405
square kilometer	square mile	0.386*
hectare (square hectometer)	acre	2.47
ounce (avoirdupois)	gram	28.35
pound (avoirdupois)	kilogram	0.45
ton (2,000 pounds)	kilogram	907.18
ton (2,000 pounds)	megagram (metric ton)	0.9
gram	ounce (avoirdupois)	0.035
kilogram	pound (avoirdupois)	2.2
megagram	ton (2,000 pounds)	1.102
ounce (U.S. liquid)	milliliter	30
cup	milliliter	247
cup	liter	0.24
gallon	liter	3.8
quart	liter	0.95
pint	liter	0.47
milliliter	ounce (U.S. liquid)	0.034
liter	gallon	0.264
liter	quart	1.057
degrees Fahrenheit	degrees Celsius	$(^{\circ}\text{F} - 32) \div 1.8$
degrees Celsius	degrees Fahrenheit	$(^{\circ}\text{C} \times 1.8) + 32$

*The conversion factors with asterisks are exact (the others give approximate conversions).

Back Cover

Metric Comparisons

- A millimeter, one-thousandth of a meter, is about the thickness of a dime.
- One inch is just $\frac{1}{64}$ inch longer than 25 millimeters (1 inch = 25.4 millimeters).
- 150 millimeters is the length of a dollar bill.
- One foot is about $\frac{3}{16}$ inch longer than 300 millimeters (12 inches = 304.8 millimeters).
- A meter is a little longer than a yard, about a yard plus the width of this notebook.

1 kilometer (about five-eighths of a mile)

|----->|

1 mile

|----->|